

SCALE 1:62,500

EXPLANATION

(Boundaries are approximate; statements are general; descriptions are based on hand specimens identified)

- Qgf** Glaciofluvial deposits: Unconsolidated, locally stratified deposits of gravel, silt, cobbles, and boulders up to 5 m in diameter, with lenses of varved silts and clays where glacial deposits predominate. Forms flat-lying to hummocky deposits on floors of stream valleys. Includes unfertilized alluvial, terminal moraine, and glacial outwash deposits. Approximate equivalent to Qal (alluvium) of Wells and Peck (1961) and Qal (alluvium) of Peck and others (1964)
- Qls** Landslide deposits: Unconsolidated blocks of bed rock and debris moved downslope via debris flow and slumping from undercutting by stream action. Material size ranges from silt- and clay-size particles to blocks 250 m in longest dimension. Prominent scarps are normally present at heads of slides.
- QTdh** Basalts of High Prairie: Upper Pliocene or Pleistocene (?), medium-gray, diktytaxitic, glomeroporphyritic, olivine-bearing basaltic flows, with euhedral to subhedral plagioclase phenocrysts. Overlies Pliocene to Miocene (?) stream gravels as series of intracanyon flows in canyon of North Fork of Willamette River north of city of Oakridge. Mapped separately from unit Tpv on basis of stratigraphic position. Flat areas tend to be blanketed by thick, brick-red, saprolitic soil. Source is thought to be large shield and composite volcanoes of the High Cascades platform east of the study area. Partially equivalent to Qv (volcanic rocks of the High Cascades) of Callaghan and Buddington (1938), Qb (basalts and andesites) of Wells and Peck (1961), and Qv (volcanic rocks of the High Cascades . . . undivided) of Peck and others (1964)
- Tpv** Pliocene volcanic rocks: Lower to middle Pliocene, medium- to light-gray, diktytaxitic, glomeroporphyritic to aphyric, olivine-bearing basaltic and andesitic flows, with euhedral to subhedral plagioclase phenocrysts. Includes interflow pyroclastic and epiclastic rocks. Caps ridges east of Middle Fork of Willamette River. East of longitude 122°15' W., occurs as dominant rock type and is mantled with glacial moraine and outwash deposits. Major source thought to be large shield and composite volcanoes east of study area. Unit is defined on basis of lithology and stratigraphic position and includes all similar rocks of Pliocene age and possibly some of Lower Pleistocene age on the eastern portion of the map area (unit QTbh excluded). Partially equivalent to Qv (volcanic rocks of the High Cascades) of Callaghan and Buddington (1938), Qb (basalts and andesites) of Wells and Peck (1961), and Qv (volcanic rocks of the High Cascades . . . undivided) of Peck and others (1964)

- Tpd** Pliocene (?) dacitic rocks: Upper Miocene or lower Pliocene (?), medium- to light-gray, diktytaxitic, fine-grained, quartz- and hypersthene-bearing dacitic flows and plugs. Found as limited outcrops directly underlying unit Tpv. Partially equivalent to Qv (volcanic rocks of the High Cascades) of Callaghan and Buddington (1938), Qb (basalts and andesites) of Wells and Peck (1961), and Qv (volcanic rocks of the High Cascades . . . undivided) of Peck and others (1964)
- Tmv** Miocene volcanic rocks: Miocene basaltic, andesitic, and dacitic lava flows and autobreccias and to a lesser extent, tuffs, lapilli tuffs, ash flows, mudflows, and debris flows. Dark-gray to black, dense, porphyritic, two-pyroxene andesites with large plagioclase phenocrysts predominate, but aphyric basaltic rocks are also common. Mafic minerals are generally altered to green clay minerals, with degree of alteration increasing toward base of unit. Flow contacts are readily identified in outcrop, and several unconformities are present within unit. Caps ridges west of Hills Creek Reservoir. Limited outcrops underlie unit Tpv east of Middle Fork of Willamette River. Unit is defined on basis of lithology, stratigraphic position, and K/Ar dates and includes all similar rocks of Miocene age (units Tms and Tmd excluded). Partially equivalent to Ta (volcanic rocks of Western Cascades) of Callaghan and Buddington (1938). Approximate time-stratigraphic equivalents of Tma (andesite and basalt) of Wells and Peck (1961) and Tsa (Sardine Formation andesite) of Peck and others (1964)
- Tmd** Miocene dioritic rocks: Middle (?) Miocene, light-gray, aphyritic, equigranular, quartz-bearing diorite, crops out locally in Salt Creek drainage only. Intruding flows of upper Tpv unit. Approximately equivalent to T1 (intrusive igneous rocks) of Callaghan and Buddington (1938) and Tg (granodiorite) of Peck and others (1964)
- Tms** Miocene silicic rocks: Lower Miocene, light-gray to red, flow-banded, aphyric to porphyritic, sandstone- to quartz-bearing rhyodacitic and dacitic flows and plugs. Occurs as dominant rock type in Eagle Butte and Dead Mountain areas and locally elsewhere throughout entire study area. Unit is defined on basis of lithology, K/Ar dates, and stratigraphic position. Partially equivalent to Ta (volcanic rocks of the Western Cascades) of Callaghan and Buddington (1938); lower part of Tma (andesite and basalt) of Wells and Peck (1961), and upper part of T1 (Little Butte Volcanic Series tuff) of Peck and others (1964)

Tov Oligocene (?) volcanic rocks: Oligocene (?) lithic tuffs, lapilli tuff, rock-fragment-rich tabular tuffs, volcanic breccias, and epiclastic rocks, and, to a lesser extent, black, dense, basaltic and andesitic autobreccias and flows. Pyroclastic rocks are generally highly sheared and massive in outcrop and altered to contain green, greenish-brown, and light-green low-grade metamorphic minerals. Lava flows are generally highly altered, with mafic minerals wholly altered to green and white clay minerals. Margins of flows are obscured in outcrop by numerous shear zones filled with clay, calcite, and green to white quartz and chalcedony. Unit is easily discernible from unit Tpv in outcrop on basis of lithology, relative degree of alteration, and shearing. Occurs as dominant rock type throughout western portion of study area. Unit is defined on basis of lithology and stratigraphic position and includes all similar rocks lying below unit Tmv. Partially equivalent to Tc (volcanic rocks of the Western Cascades) of Callaghan and Buddington (1938). Approximate time-stratigraphic equivalent to Tmp (pyroclastic rocks) of Wells and Peck (1961) and T1 (Little Butte Volcanic Series tuffs) of Peck and others (1964)

- GEOLOGIC SYMBOLS**
- Contacts - All contacts for this study are approximately located and based on reconnaissance mapping only
 - Normal fault - Solid where shown, dashed where inferred, dotted where concealed, ball and bar on downthrown side
 - Strike line - Dashed where inferred
 - Strike and dip of beds
 - Spec line - Dashed where inferred
 - Flat-lying beds
 - Volcanic center - Includes volcanic pipes, rocks, plugs, and related outcrops
- Areas of general rock alteration - Areas of propylitic to argillitic alteration. Alteration table includes deposits of one or more of the following: opatic, calcite, iron, pyrite, barite, hematite, specularite, pyrrhotite, and clay minerals

TIME ROCK CHART

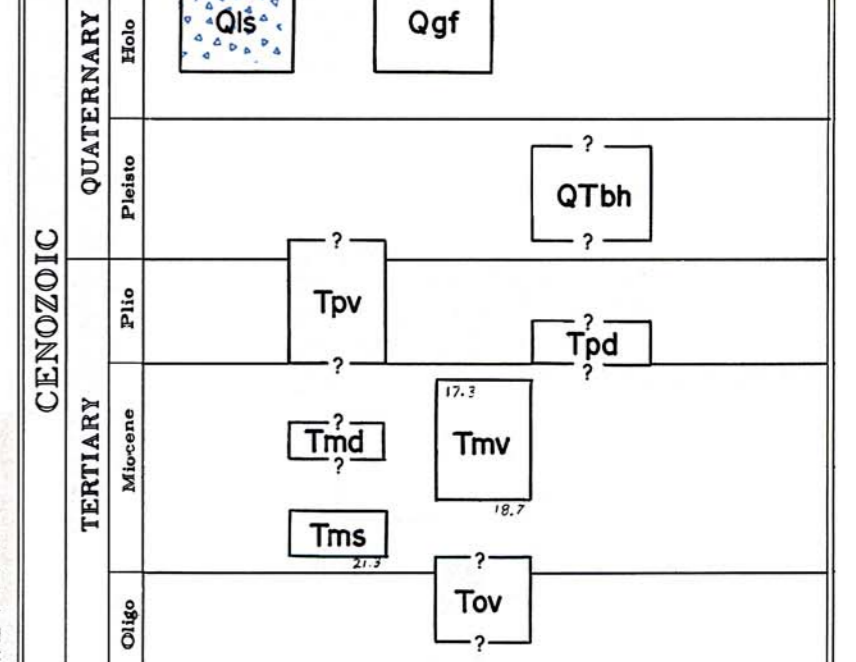

- GRADIENT (°C/km)
- DEPTH PROBED
- HOLE LOCATION
- HEAT FLOW (mW/m²)
- BOTTOM HOLE TEMP (°C)
- THERMAL SPRING
- WATER TEMP (°C)
- COLD SPRING
- WATER TEMP (°C)
- K/AR AGE - DATE LOCATION
- ROCK CHEMISTRY LOCATION WITH TEXT REFERENCE

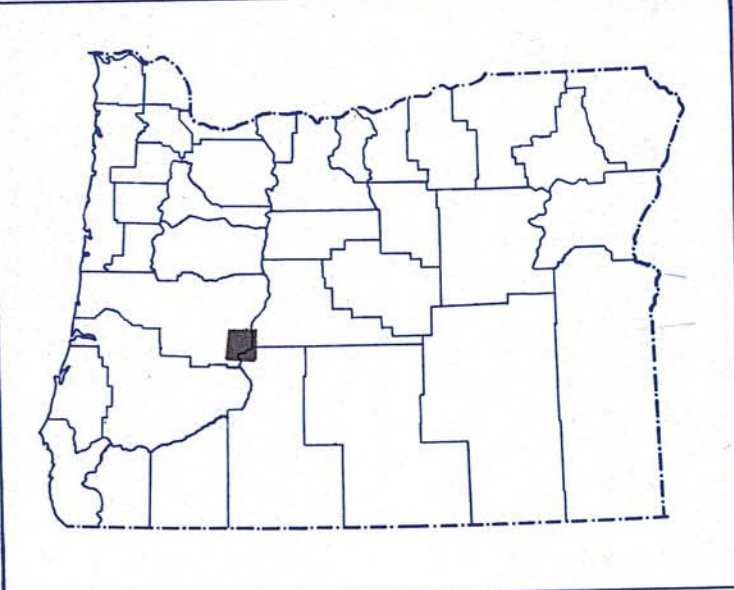

SECTIONIZED TOWNSHIP

6	5	4	3	2	1
7	8	9	10	11	12
13	14	15	16	17	18
19	20	21	22	23	24
25	26	27	28	29	30
31	32	33	34	35	36



Mapped, edited, and published by the Geological Survey
Control by USGS, USC&GS, USCE, and State of Oregon
Topography from aerial photographs by multiple methods
Aerial photographs taken 1954. Field check 1956
Polyconic projection. 1927 North American datum
10,000-foot grid based on Oregon coordinate system.
South zone
1000-meter Universal Transverse Mercator grid lines,
zone 10, shown in blue
Red tint indicates areas in which only
landmark buildings are shown
Dashed land lines indicate approximate locations
Unchecked elevations are shown in brown

Geologic Cross Sections

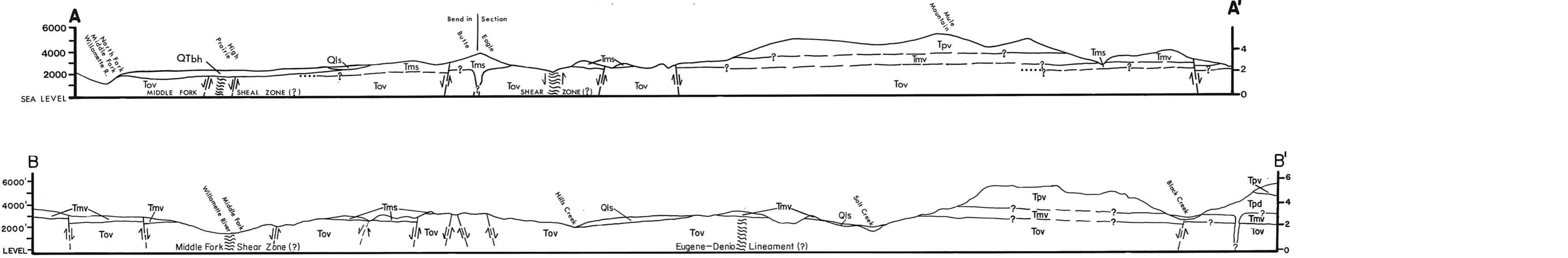

Geology by David E. Brown, Gary D. McLean, Neil M. Woller, and Gerald L. Black. Adapted from Callaghan and Buddington, 1938; Wells and Peck, 1961; and Peck and others, 1964

STATE OF OREGON
DEPARTMENT OF GEOLOGY AND MINERAL INDUSTRIES
1005 State Office Building
Portland, Oregon 97201

OPEN-FILE REPORT O-80-3

PRELIMINARY GEOLOGY AND
GEOTHERMAL RESOURCE POTENTIAL
OF THE
WILLAMETTE PASS AREA,
OREGON

by

D. E. Brown,

G. D. McLean,

N. M. Woller, and

G. L. Black

Under the direction of J. F. Riccio

Study completed under U. S. Department of Energy
Cooperative Agreement No. DE-FC07-79ET27220
and Oregon Department of Energy Contract No. 1-003-33

1980

DISCLAIMER

This report has not been edited for complete conformity with Oregon Department of Geology and Mineral Industries standards. Data in this document are preliminary and are subject to change upon further verification.

CONTENTS

INTRODUCTION	1
GEOLOGY	3
Introduction	3
Volcanic stratigraphy	4
Structural geology	6
Relation of structures to geothermal systems	8
GEOPHYSICS	9
WATER CHEMISTRY	14
GRADIENT DATA AND HEAT FLOW	21
CONCLUSIONS AND RECOMMENDATIONS	25
BIBLIOGRAPHY	27
APPENDIX A	33

ILLUSTRATIONS

FIGURES

1. Map showing location of study area, Willamette Pass area, Oregon	2
2. Photo-lineament map, Willamette Pass area	7
3. Total field aeromagnetic anomaly map, Willamette Pass area	10
4. Complete Bouguer anomaly map, Willamette Pass area	11
5. Residual gravity anomaly map, Willamette Pass area	12

TABLES

1. Radiometric (K/Ar) ages for selected rocks, Willamette Pass area	3
2. Bulk chemical composition for selected rocks, Willamette Pass area	5
3. Spring and well chemistry, Willamette Pass area	15
4. Geothermetric calculations of minimum reservoir temperatures for thermal waters, Willamette Pass area	19
5. Geothermal-gradient data, Willamette Pass area	22

MAPS (folded, in envelope)

Plate I. Reconnaissance geology of the Willamette Pass area, Oregon

INTRODUCTION

The Willamette Pass area is located in the central Western Cascade Range of Oregon approximately 80 km (50 mi) east of Eugene, Oregon, up the Willamette River drainage (Figure 1). Limits of the study area were arbitrarily assigned to U.S. Geological Survey (USGS) topographic map boundaries and to natural breaks in the geology and topography (Plate I). This study, performed under U.S. Department of Energy (USDOE) Contract No. DE FC07-79ET27220 and Oregon Department of Energy Contract No. 1-003-33, was undertaken to estimate the geothermal potential of the area, using various methods including compilation of existing data, reconnaissance geologic mapping, lineament analysis, well and spring geochemistry, and accrual of geothermal-gradient data.

Geographically, the study area is located in the rugged mountains immediately east of Oakridge, Oregon, which is located at the western edge of the map. Drainage in the area is through two forks of the Willamette River, Salmon Creek, and Salt Creek, from the east towards the west via deep, V-shaped canyons.

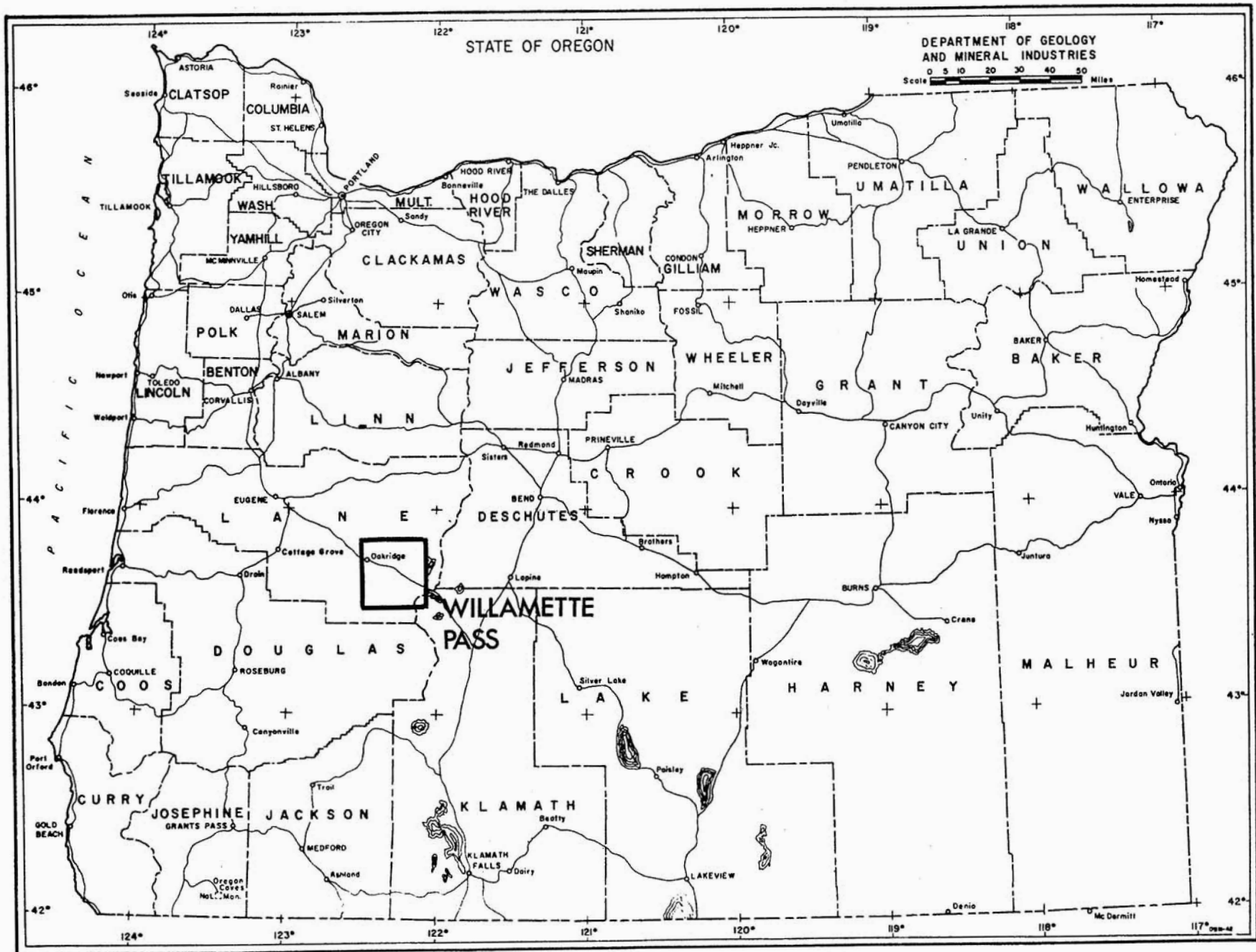

Figure 1: Map showing location of study area.

GEOLOGY

Introduction

The Willamette Pass area encompasses parts of both the Western Cascades and High Cascades geologic provinces (Figure 1). The area is dominated in the western part by older Western Cascades Oligocene tuffaceous rocks and Miocene lavas (Plate 1) and in the eastern part by High Cascade lavas of Quaternary and latest Tertiary age and Pliocene lavas. High-angle normal faults cut the area in numerous places, following chiefly north and northwest trends; a major northwest-trending lineament, the Eugene-Denio lineament, crosses the area (Lawrence, 1976). Alteration zones and local Miocene volcanic centers near these faults and lineaments have obscured important relationships in the Western Cascades province. It was found during this study that the geology and structure of the Willamette Pass area were generally more complex to interpret than those of the Belknap-Foley area to the north.

Table 1. Radiometric (K/Ar) ages for selected rocks of the Willamette Pass area

<u>Sample no.*</u>	<u>Location</u>	<u>Rock type</u>	<u>Age (m.y.)</u>	<u>Stratigraphic unit</u>
OM-5	122 ⁰ 20'09" 43 ⁰ 34'15"	Dacite	21.3±1.0	Tms
OM-520	122 ⁰ 22'15" 43 ⁰ 48'45"	Rhyolite	17.3±0.7	Tms
OM-49	122 ⁰ 23'24" 43 ⁰ 36'41"	Basalt	18.7±0.9	Tmv

*OM - analyzed for this report by University of Utah Research Institute (UURI), Stanley Evans and Duncan Foley, analysts.

Volcanic stratigraphy

The geologic history of the Willamette Pass area resembles the history of the Belknap-Foley area to a remarkable degree. Volcanism in both areas changed from silicic pyroclastic activity in the Oligocene to eruption of greater quantities of lavas of increasingly more mafic composition from Miocene to Quaternary times. One major difference between the eruptive history of the two areas is the extrusion of sanidine-phyric rhyolitic to dacitic lavas and tuffs (unit *Tms*, Plate I) in the Willamette Pass area during the early Miocene. No potassic sanidine-bearing units are known in the Belknap-Foley area.

Dacitic to rhyodacitic laharc tuffs and ash-flow tuffs (e.g., P-2 in Table 2) and minor basaltic lavas erupted in the Oligocene over the entire Western Cascade region (unit *Tov*, Plate I). No reliable radiometric dates are available for these tuffs, but overlying lavas have been dated at 22 ± 1 m.y., near Lookout Point, north of the study area (unpublished K/Ar data by University of Utah Research Institute (UURI), Stanley Evans and Duncan Foley, analysts). These eruptions were followed by a period of erosion that produced a steep topography which was filled in by repeated eruptions of lavas and subordinate tuffs during the Miocene. A distinctive series of short flows and ash flows of sanidine-bearing rhyolitic rocks lies at the base of the Miocene section (unit *Tms*, Plate I). These rhyolitic rocks are not present north of the area and are overlain by a thick stack of Miocene lavas of intermediate to mafic composition (unit *Tmv*, Plate I). Numerous plug domes of units *Tms* and *Tmv*, including some dioritic intrusions (unit *Tmd*, Plate I), mark old volcanic centers throughout the area. The Fall Creek mining district on the northern margin of the area has a high concentration of these intrusive bodies. Unit *Tms* has been dated at 21.3 ± 1.0 m.y. and 18.7 ± 0.9 m.y., whereas a basaltic lava of unit *Tmv* was 17.3 ± 0.7 m.y. old (Table 1; unpublished K/Ar data by UURI, Evans and Foley, analysts).

Table 2. Bulk chemical composition of selected rocks of Willamette Pass area. (Letters at top of each column indicate sample number and map symbol for stratigraphic unit. All values are in weight percent.)

<u>Component</u>	<u>*P-1</u> <u>Tms</u>	<u>P-2</u> <u>Tov</u>
SiO ₂	69.20	71.00
TiO ₂	0.58	0.38
Al ₂ O ₃	14.70	14.80
Fe ₂ O ₃	2.80	2.00
FeO	1.30	0.49
MnO	0.08	0.01
MgO	0.62	0.49
CaO	2.10	1.80
Na ₂ O	4.90	3.80
K ₂ O	2.60	3.60
P ₂ O ₅	0.09	0.04
H ₂ O	1.28	1.60
CO ₂	<u>0.14</u>	<u><0.05</u>
Total	100.22	99.97

*References: P - from Peck and others, 1964.

Aside from some minor epiclastic sediments, the late Miocene to Quaternary section is completely dominated by mafic lavas. Late Miocene to early Pliocene quartz- and hypersthene-bearing dacites (unit *Tpd*, Plate I) are volumetrically subordinate to overlying Pliocene basaltic to basaltic-andesitic lavas (unit *Tpv*). These distinctive Pliocene lavas generally have diktytaxitic textures and phenocrysts of relatively fresh or moderately iddingsitized olivine. Unit *Tpv* rocks are lithologically similar to Pliocene-Pleistocene basaltic flows of the Basalts of High Prairie (informal name), shown as unit *QTbh* on Plate 1. The Basalts of High Prairie are, however, obviously intracanyon into the Pliocene lavas along the North Fork of the Middle Fork of the Willamette River (Plate 1). The Pliocene and Pleistocene basaltic lavas appear to thicken toward their source in the High Cascades, to the east.

Structural geology

Mapped faults in the Willamette Pass area are generally high-angle normal faults with northwesterly trends, although east-west-, northeasterly- and north-trending faults are also common locally (e.g., at Huckleberry Mountain and Squaw Butte, Plate I). These generalizations also apply to the lineament map (Figure 2); a major N.55°W.-trending lineament appears on the lineament map following Kitson Ridge and Lookout Point Reservoir (Figure 2). This lineament, which has not, however, been proven to be a fault (Plate I) is the Eugene-Denio lineament, considered by Lawrence (1976) to possibly be the result of right-lateral oblique-slip faulting. Hydrothermal alteration is anomalously intense in Miocene and older rocks along the Eugene-Denio lineament, although such alteration is also present along other lineaments and mapped faults, as well. In any case, none of this alteration affects Pliocene capping lavas along the lineament. Only faults trending nearly north-south to N.30°W. and rare east-west faults appear to cut the Pliocene capping lavas (e.g., at Huckleberry Mountain, Plate I). It may be that

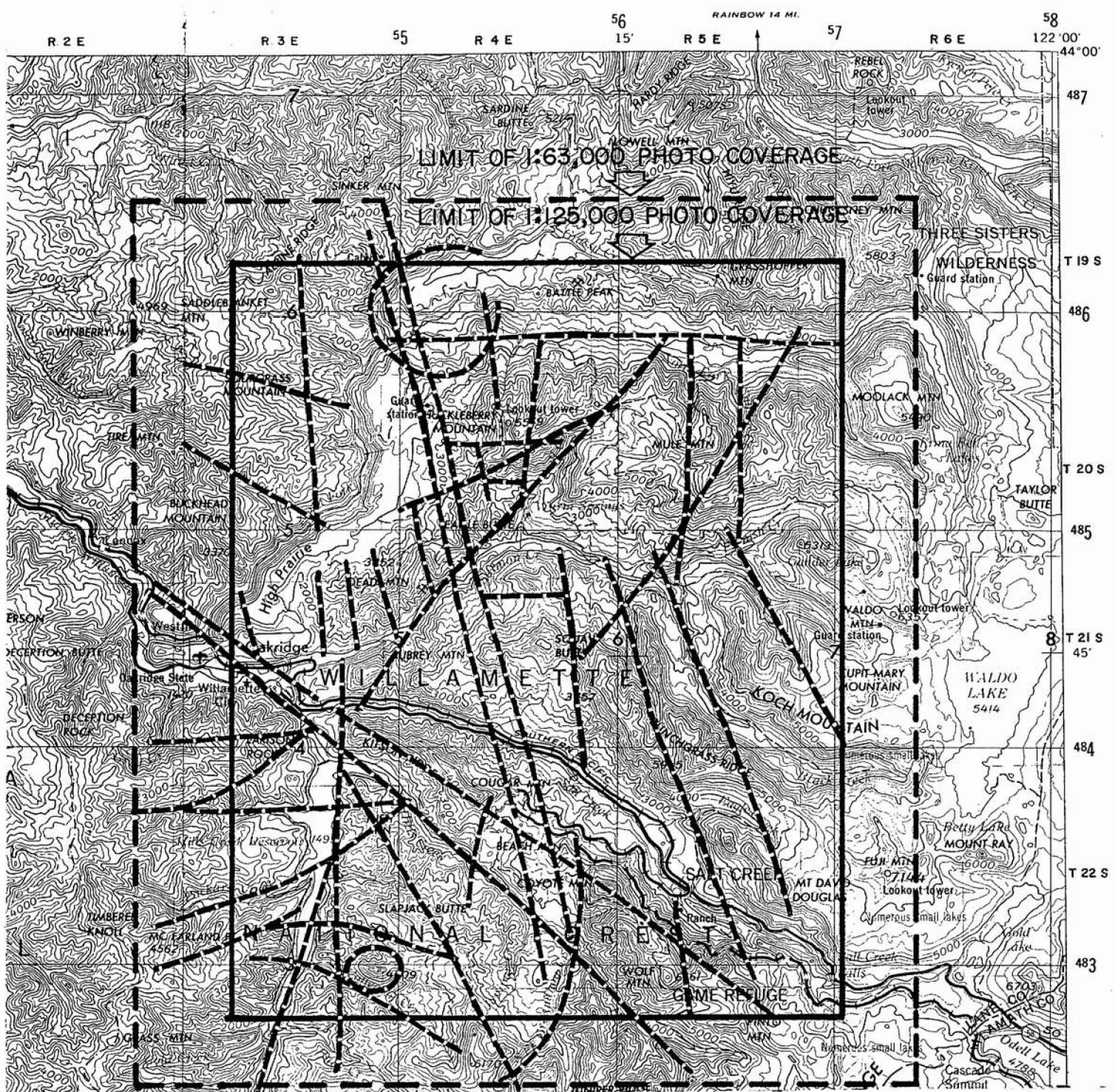

Scale 1:250,000

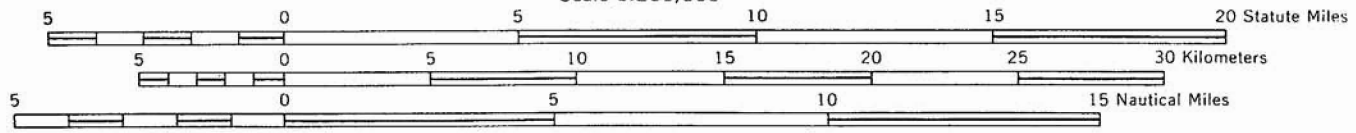

CONTOUR INTERVAL 200 FEET

ROSEBURG, OREGON
1958
REVISED 1970

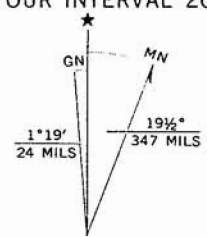

Figure 2.
PHOTO-LINEAMENT MAP
OF

UTM GRID AND 1967 MAGNETIC NORTH DECLINATION AT CENTER OF SHEET

WILLAMETTE PASS AREA

faults subparallel to the Eugene-Denio lineament were active prior to north-south- and east-west-trending faults and prior to the Pliocene.

North-south-trending faults in the Willamette Pass may be cogenetic with similar north-south-trending normal faults in the Belknap-Foley Hot Springs area to the north. The Belknap-Foley area has two major north-south-trending fault zones which appear to control the distribution of hot springs. The most prominent fault zone in the Belknap-Foley area is the western margin of the High Cascades graben (Allen, 1966). Delineation of the High Cascades graben in the Willamette Pass area is, however, not possible, because the study area does not quite overlap what is probably the western topographic scarp of the graben. The topographic margin appears to be approximately at the east sides of Moolack and Waldo Mountains (Figure 2).

Relationship of structure to the geothermal systems

All of the thermal springs in the Willamette Pass area are in topographic lows within the Oligocene volcanic sequence (Plate I). All of the thermal springs are also on or near major lineaments or mapped faults. Kitson Hot Springs is located on the Eugene-Denio lineament where east-west- and northeast-trending lineaments intersect (Figure 2). A major north-trending lineament passes by McCredie Hot Springs, and mapped faults trending west-northwest and northeast intersect at the Wall Creek warm springs (Plate I).

It may be that some degree of fracture permeability is essential for passage of geothermal water. The bedrock host for the hot springs in every case is relatively highly altered Oligocene volcanic rock. The altered rocks generally have low permeability, as demonstrated by past experience with wells in the area. Enhancement of permeability by pervasive fracturing may be necessary to create geothermal aquifers in this area.

GEOPHYSICS

Two geophysical studies were available for evaluation in this report. A regional aeromagnetic study (Figure 3) which was performed by the Oregon State University Geophysics Group is discussed in detail by Couch (1978) and Connard (1980). This study, in general, seems to indicate a close correspondence between magnetic maxima and topographic highs in the Willamette Pass area. This correspondence is probably because the Pliocene and Pleistocene units found capping the ridges tend to have a higher proportion of magnetically susceptible minerals than the older, underlying Miocene and Oligocene rocks.

Site-specific interpretations of the aeromagnetic data for the study area are not obvious. However, regional interpretation by Couch (1978) and Connard (1980) indicates a possible north-south-striking fault with east side down in the approximate location of the Hills Creek Reservoir-Flat Creek fault zone. The motion on this fault zone, however, was mapped in this study as east side up, based on relative offset of units. A second fault has been placed by Couch (1978) and Connard (1980) along the Eugene-Denio lineament (Lawrence, 1976), who have inferred a right-lateral motion using offsets of magnetic anomalies to the east. The depth to Curie point isotherm ($\sim 600^{\circ}\text{C}$) is also estimated to be greater on the west side of the north-south-striking fault than on the east side. Blackwell and others (1978) present a thermal model of the Cascades which estimates a similar depth to the 600°C isotherm.

The second geophysical study is a regional gravity survey also performed by the Oregon State University Geophysics Group (Couch, 1978; Pitts, 1979). This study (Figures 4 and 5) is presented as both a complete Bouguer gravity anomaly map and a residual anomaly map, both of which are discussed in detail by Couch (1978) and Pitts (1979). The main feature of both these maps is the steep gravity

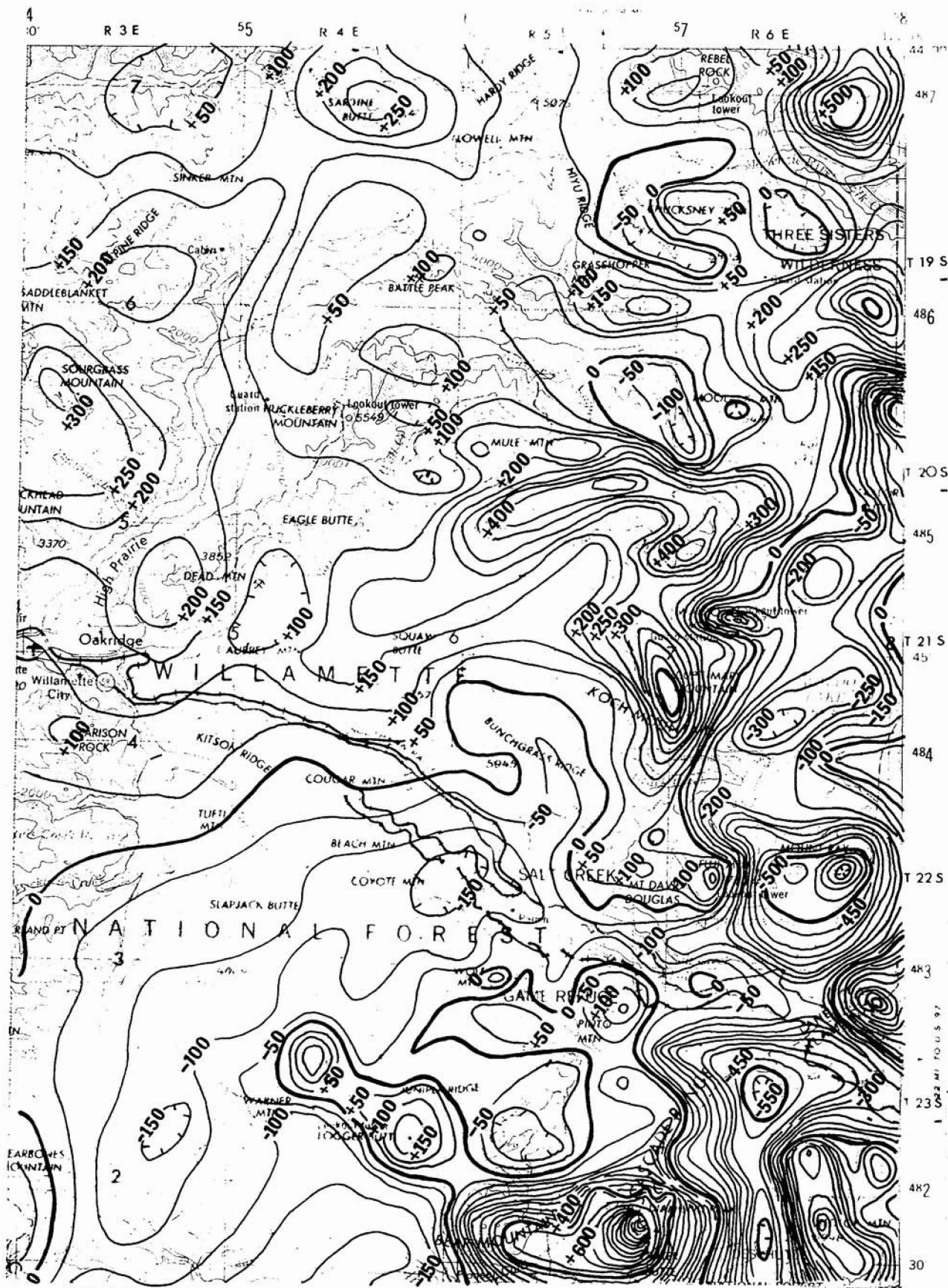

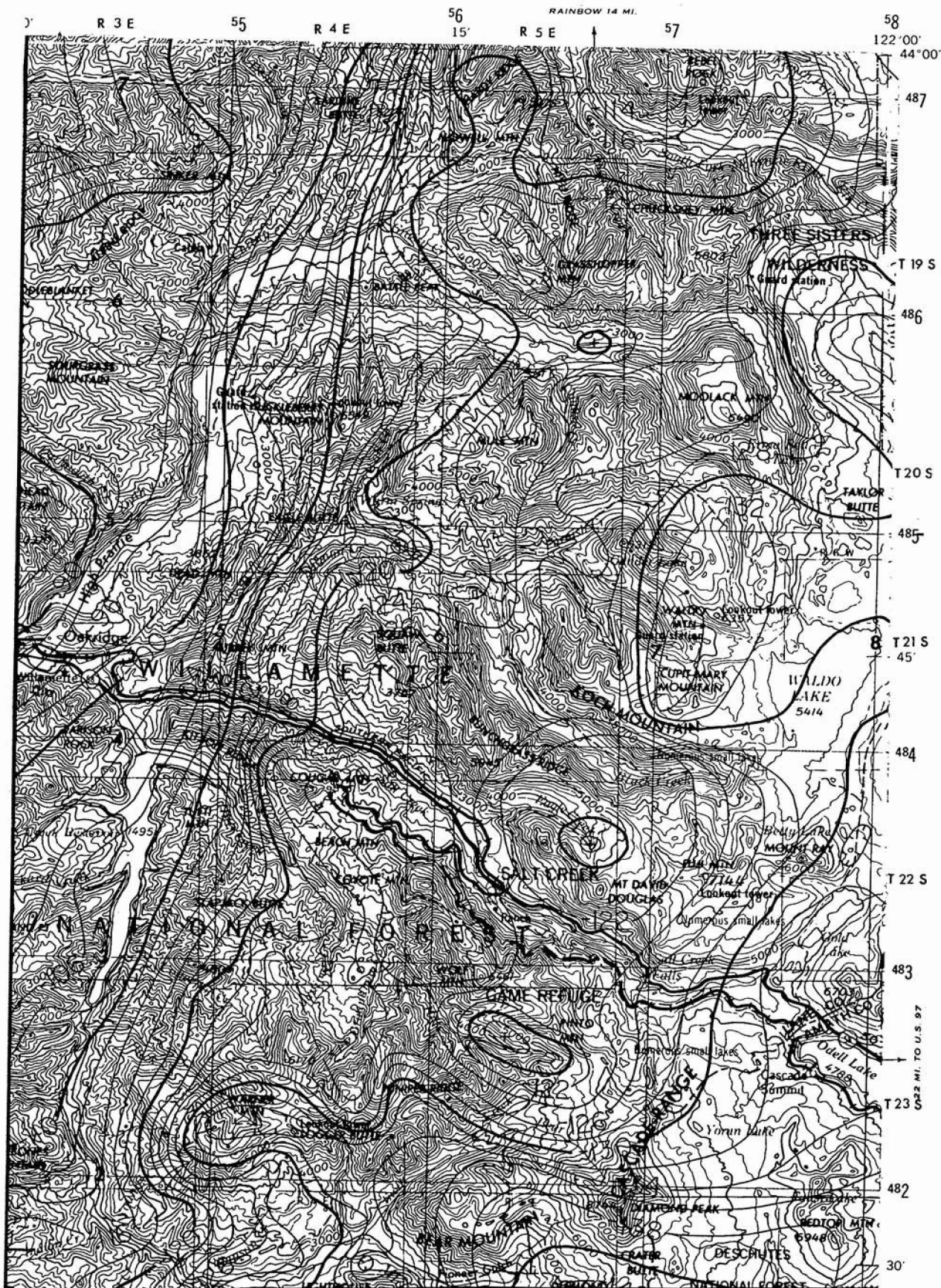
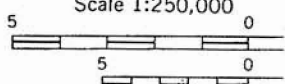

Figure 4.

COMPLETE BOUGUER ANOMALY MAP OF WILLAMETTE PASS AREA
 (From Pitts and Couch, 1978) Contour interval 2.0 mgal



ROSEBURG, OREGON

1958

REVISED 1970

Estimated uncertainty 1.0 mgal
 Reduction density 2.67 g/cm³
 Transverse Mercator Projection
 Theoretical gravity: IGF (1930)

gradient coincident with the Hills Creek Reservoir-Flat Creek fault zone and the location of local thermal springs and wells. Pitts (1979) and Couch (1980) interpret this anomaly to represent either a large graben-bounding fault zone with east side down, an area of shallow silicic intrusives, or a possible combination of both. Detailed geologic mapping and possibly deep drilling is needed to further refine geologic modeling based on the geophysical studies in this report.

WATER CHEMISTRY

During the period of this study, eight springs, wells, and geothermal-gradient holes were sampled and their waters analyzed. Together with published analyses (Mariner and others, 1974; Mariner and others, 1980), a total of eighteen analyses were available for evaluation (Table 3). The analyses were then used to calculate minimum reservoir temperatures (Table 4), using standard formulae for geothermometry which are included, together with references, as Appendix A. Preliminary evaluation of available data indicates that the thermal waters can be best described as a neutral to mildly alkaline, saline, carbonate water generally diagnostic of a hot-water-dominated system at depth. Calculated reservoir temperatures indicate subsurface temperatures are in the moderate range (80-120°C), which is typical of other areas in the Cascades. Geochemical and geologic controls of the geothermal system are not obvious; however, a pattern of increasing ion concentrations is seen from north to south (i.e., from Wall Creek Springs, to McCredie Springs, to Kitson Springs and Saline Well). Ionic concentration increases are apparent in total dissolved solids, sodium, potassium, calcium, ammonia, and chloride. No explanation is apparent from preliminary examination of the analyses; however, this increase may indicate a larger contribution to the thermal waters from connate water trapped in Eocene sediments found at depth. This depth to sediments may be relatively more shallow than in the northern parts of the Cascades, which may be the reason for the relatively high abundance of salt springs and "soda" springs found in the southern Cascades. Any further geochemical modeling is dependent on the collection and analysis, including gas and isotopic studies, of samples from more springs and wells.

Table 3. Spring and well chemistry of the Willamette Pass area. All measurements are in mg/l, except for pH or as indicated. nt = not tested; tr = trace.

	<u>McCredie Springs #1</u>	<u>McCredie Springs #1</u>	<u>McCredie Springs #3</u>	<u>McCredie Springs #2</u>	<u>Wall Creek Springs</u>
Location	21S/4E/36Bc	21S/4E/36Bc	21S/4E/36Bc	21S/4E/36Bc	20S/4E/26Bc
Date sampled	'74	10/76	10/76	8/80	3/76
Temp. (°C)	73.0	71.0	66.0	62.0	41.0
pH	7.3	7.4	7.4	7.2	7.2
Conductance µmhos/cm	6730	6770	6800	6750	2340
Alkalinity X_h as mg/l HCO_3 X_c as mg/l $CaCO_3$	21 _h	16 _c	16 _c	16 _c	34 _c
Hardness as mg/l $CaCO_3$	nt	1380	1364	nt	nt
Total dissolved solids	nt	4420	4584	4200	1461
SiO ₂	79	65	71.8	78.4	63
Na	1000	910	915	885	315
K	22.0	28.0	27.6	21.8	11.0
Ca	460	500	495	456	130
Mg	0.9	0.9	1.1	2.42	1.0
Cl	2200	2232	2308	2030	602
As	nt	0.08	0.07	0.11	0.07
B	18.0	17.8	19.5	9.91	6.6
Li	1.40	1.98	2.0	1.48	0.57
F	2.70	2.68	2.86	2.3	4.1
Fe (total)	0.02	0.1	0.1	0.43	0.05
Al	0.01	tr	tr	0.47	tr
HCO ₃	nt	20	20	nt	nt
PO ₄	0.61	0.11	0.22	nt	0.16
SO ₄	240	185	218	271	108
NO ₃	nt	tr	tr	nt	nt
NH ₃	0.26	0.21	0.14	nt	0.1

Table 3. Spring and well chemistry of the Willamette Pass area--Continued. All measurements are in mg/l, except for pH or as indicated. nt = not tested; tr = trace.

	<u>Wall Creek Springs</u>	<u>Kitson Springs</u>	<u>Kitson Springs</u>	<u>Kitson Springs</u>	<u>Kitson Brine well</u>
Location	20S/4E/26Bc	22S/4E/6Add	22S/4E/6Add	22S/4E/6Add	22S/4E/6Add
Date sampled	8/80	3/58	5/78	8/79	'78
Temp. (°C)	40.0	44.4	43.0	44.0	nt
pH	7.6	7.4	7.3	6.8	6.8
Conductance µmhos/cm	2288	10500	10100	10500	10000
Alkalinity X_h as mg/l HCO_3^- X_c as mg/l $CaCO_3$	35 _c	nt	24 _h	18 _c	nt
Hardness as mg/l $CaCO_3$	nt	nt	nt	1900	1900
Total dissolved solids	1500	6340	nt	5930	5000
SiO ₂	73.2	47	45	47	nt
Na	299	1450	1500	1450	nt
K	8.5	28	26	28	nt
Ca	114	726	710	726	nt
Mg	0.53	5.7	1.6	5.7	nt
Cl	600	3420	3450	3420	nt
As	0.07	nt	nt	0.26	0.26
B	nt	25	22	25	nt
Li	0.43	1.8	2.0	2.02	nt
F	4.0	2.8	2.4	2.6	nt
Fe (total)	0.32	0.01	0.04	2.0	2.0
Al	0.52	0.27	tr	0.14	nt
HCO ₃	nt	27	nt	27	nt
PO ₃	nt	0.54	nt	nt	nt
SO ₄	160	197	210.0	197	nt
NO ₃	0.02	2.7	nt	nt	nt
NH ₃	nt	nt	nt	nt	nt

Table 3. Spring and well chemistry of the Willamette Pass area--Continued. All measurements are in mg/l, except for pH or as indicated. nt = not tested; tr = trace.

	<u>Kitson Brine well</u>	<u>Salt Spring</u>	<u>Hills Creek Drill hole 90 ft-410 ft</u>	<u>Oakridge #1 Drill hole 670 ft</u>
Location	22S/4E/6Add	21S/3E/17Cd	21S/3E/26Caa	21S/3E/17Daa
Date sampled	8/80	6/79	8/80	8/80
Temp. ($^{\circ}$ C)	30.0	18.0	14.5	22.1
pH	8.75	7.4	8.75	7.45
Conductance μ mhos/cm	10300	8800	nt	8500
Alkalinity X_h as mg/l HCO_3^- X_c as mg/l CaCO_3	nt	365 _c	nt	nt
Hardness as mg/l CaCO_3	1165	1433	154	1477
Total dissolved solids	6214	5300	424	5028
SiO_2	13(?)	29	21	3(?)
Na	1573	1250	39	1344
K	10	45.8	<2.50	24
Ca	848	490	28	466
Mg	2	51	9	40
Cl	3423	2800	105	2676
As	<0.625	0.01	<0.625	<0.625
B	20.3	10.5	0.3	6.9
Li	2.05	0.93	<0.050	<0.050
F	2.0	3.7	0.4	<0.1
Fe (total)	<0.025	21.7	<0.025	<0.025
Al	<0.625	0.26	<0.625	<0.625
HCO_3^-	nt	nt	nt	nt
PO_4	nt	nt	nt	nt
SO_4	193	82.9	145	170
NO_3^-	nt	nt	nt	nt
NH_3	1.2	3.46	0.1	0.8

Table 3. Spring and well chemistry of the Willamette Pass area--Continued.
 All measurements are in mg/l, except for pH or as indicated. nt = not tested;
 tr = trace.

	<u>Black Creek Drill Hole</u>	<u>Christy Creek Drill Hole</u>	<u>Wall Creek Drill Hole</u>	<u>Brock Creek Drill Hole</u>
Location	21S/5E/16Ac	19S/4E/29Ccb	20S/4E/27Ddd	19S/5E/27Bcc
Date sampled	6/10/80	7/1/80	6/3/80	6/5/80
Temp. (°C)	8.47	16.89	18.94	16.23
pH	7.58	7.23	8.27	8.61
Conductance µmhos/cm	89.5	106	17200	250
Alkalinity X _h as mg/l HCO ₃ X _c as mg/l CaCO ₃	nt	nt	nt	nt
Hardness as mg/l CaCO ₃	42.8	34.2	68.4	17.1
Total dissolved solids	86	116	966	88
SiO ₂	25*	21*	23*	22*
Na	6	11	335	4
K	<2.50	<2.50	<2.50	<2.50
Ca	10	7	26	8
Mg	4	3	<0.500	3
Cl	15.2	7.58	579.0	15.2
As	<0.625	<0.625	<0.625	<0.625
B	<0.125	<0.125	6.0	<0.125
Li	<0.050	<0.050	<0.050	<0.050
F	<0.1	0.1	3.5	<0.1
Fe (total)	0.99	0.34	0.04	0.14
Al	0.7	<0.625	<0.625	<0.625
HCO ₃	nt	nt	nt	nt
PO ₄	nt	nt	nt	nt
SO ₄	<2	4	83	<2
NO ₃	nt	nt	nt	nt
NH ₄	nt	0.4	0.2	0.3

*Results may reflect a loss of SiO₂ due to sampling technique and delayed filtering of sample.

Table 4. Geothermetric calculations* of minimum reservoir temperatures for selected thermal waters of the Willamette Pass area

	Kitson Springs	Kitson Springs	Kitson Springs	McCredie Springs #1	McCredie Springs #1	McCredie Springs #3
Flow rate liters/min.	66	50	50	50	50	76
Measured temperature °C	44.4	43	44	73	71	66
Na:K °C	82	77	81	88	104	103
Na:K:Ca 1/3 β °C	110	107	102	114	125	125
Na:K:Ca 4/3 β °C	83	81	83	81	86	86
Na:K:Ca Mg corrected °C	NC	71	NC	74	84	NC
SiO ₂ conductive °C	99	97	99	124	115	113
SiO ₂ adiabatic °C	100	98	99	122	114	112
SiO ₂ chalcedony °C	69	67	69	96	86	84
SiO ₂ opal °C	-16	-18	-16	6	-3	1

*Methodology for calculations presented in Appendix A. NC = not calculated.

Table 4. Geothermometric calculations* of minimum reservoir temperatures for selected thermal waters of the Willamette Pass area -- Continued

	McCredie Springs #2	Wall Creek Springs	Salt Spring	Black Creek Drill Hole	Christy Drill Hole	Wall Creek Drill Hole	Brock Creek Drill Hole
Flow rate liter/min.	50	11	2	13	pumped	pumped	pumped
Measured temperature °C	62	41	18	8.5	16.89	18.94	8.61
Na:K °C	104	110	66	NC	NC	NC	NC
Na:K:Ca 1/3 β °C	126	125	138	NC	NC	NC	NC
Na:K:Ca 4/3 β °C	87	73	108	NC	NC	NC	NC
Na:K:Ca Mg corrected °C	NC	NC	105	NC	NC	NC	NC
SiO ₂ conductive °C	124	120	78	72 (?)	65 (?)	69 (?)	67 (?)
SiO ₂ adiabatic °C	122	118	82	77 (?)	71 (?)	74 (?)	72 (?)
SiO ₂ chalcedony °C	95	92	46	40 (?)	33 (?)	37 (?)	35 (?)
SiO ₂ opal °C	25	-5	-17	-39 (?)	-45 (?)	-42 (?)	-43 (?)

*Methodology for calculations presented in Appendix A. NC = not calculated.

GEOHERMAL-GRADIENT AND HEAT-FLOW DATA*

The temperature-gradient and heat-flow results for the Willamette Pass area are shown in Table 5. Included in the table are the township/range-section and latitude and longitude location of each hole for which temperature data are available. In addition, the hole name, date of logging used, and collar elevation are included for each hole. The bottom hole temperature, maximum depth, corrected temperature gradient, and, where available, corrected heat flow are printed in blue on Plate I. These values are also listed in the table, as are the depth interval and average thermal conductivity used for calculation of the gradient and heat flow. The values are given in SI units. To transform units, the following conversion factors were used: $1 \times 10^{-6} \text{ cal/cm}^2\text{sec (HFU)} = 41.84 \text{ mWm}^{-2}$, $1 \times 10^{-3} \text{ cal/cm sec}^{\circ}\text{C (TCU)} = 0.4184 \text{ Wm}^{-1}\text{K}^{-1}$, and $1^{\circ}\text{C/km} = 1 \text{ mKm}^{-1} = 18.2 \text{ }^{\circ}\text{F/100 ft}$. Corrected gradient and corrected heat flow are values for which the topographic effects have been removed. These are significant for many of the sites studied.

The holes are ranked in terms of the quality of the gradient or heat-flow information: high quality (A), good quality (B), marginal quality (C), data with some problems (D), and data for which no useful temperature gradient or heat flow can be estimated (X). All thermal-conductivity measurements were made on cutting samples. Most of the holes shown on the table were drilled specifically for heat-flow studies, and so the data quality is relatively high. In general, holes drilled in the Western Cascade rocks give linear gradients below near-surface effects that may vary in depth from 20 to 100 m. Holes 50-150 m deep in High Cascade rocks, such as 21S/5E-16AcD, are often isothermal because of lateral flow of water in the porous young volcanic rocks.

*By D. D. Blackwell, Southern Methodist University, Dallas, Texas.

Table 5. Geothermal-gradient data, Willamette Pass area, Oregon

Twn/Rng- Section	N Lat. Deg.Min.	W Long Deg.Min.	Hole # Date	Collar Elev.	Bottom Temp. (°C)	Depth Interval (m)	Avg. TC $\text{Wm}^{-1}\text{K}^{-1}$	# TC	Uncorr. Gradient °C/km	Corr. Gradient °C/km	Corr. HF mWm^{-2}	Q HF
19S/ 6E- 8BA	43-56.96	122- 1.85	ELK CRK 7/ 9/80	877	18.23	40.0 135.0	1.22 .04	10	43.2 1.0	33.3	41	B
19S/ 5E- 27BCC	43-53.31	122-12.61	BRCK CRK 7/31/80	987	16.23	135.0 154.0	1.75 .09	3	65.8 .4	65.6	115	B
19S/ 4E- 29CCB	43-53.00	122-16.47	CHRS CRK 7/31/80	579	16.89	70.0 154.0	1.75 .09	4	64.0 1.1	52.3	92	B
19S/ 6E- 25DCD	43-52.95	122- 4.11	N FORK 7/31/80	951	18.88	30.0 154.0	1.35 .05	4	78.4 5.1	67.5	91	
20S/ 3E- 26DA	43-48.01	122-24.95	CS-WW 9/28/76	719	12.85	45.0 70.0	(1.59)		25.3 1.8	25.1	40	B
						70.0 140.0	(1.17)		39.0 .5	38.8	46	B
20S/ 4E- 27DDD	43-47.94	122-18.83	WALL CRK 7/11/80	582	17.80	30.0 135.0	1.13 .13	7	72.6 .9	60.5	69	B
20S/ 3E- 26CD	43-47.88	122-25.18	AE-WW 8/19/76	707	11.88	10.0 80.0	(1.59)		25.8 .5	25.6	41	B
						80.0 125.0	(1.17)		36.5 .8	36.3	43	B
21S/ 3E- 10AD	43-45.64	122-25.93	FC-WW 9/28/76	548	13.20	25.0 100.0	(1.17)		36.5 .5	35.6	42	B
21S/ 5E- 16ACD	43-44.85	122-14.60	BLCK GRK 8/ 1/80	829	7.97	45.0 104.0			6.2 .6			X
21S/ 3E- 17DA	43-44.80	122-28.25	OAKR CW6 2/21/79		17.71	70.0 125.0			47.7 2.9			C
21S/ 4E- 28AD	43-43.15	122-19.97	CR-MCHSE 9/29/76	533	20.98	10.0 150.0	1.67	13	82.3 .4	60.0	101	B
21S/ 3E- 35B1	43-42.50	122-25.50	DH-Z-5 11/25/75	413	11.02	20.0 27.5			52.3 1.5			X
21S/ 3E- 35B3	43-42.50	122-25.50	DH-Z-2 11/25/75	459	10.45	60.0 79.0			5.8 .3			X

Table 5. Geothermal-gradient data, Willamette Pass area, Oregon--Continued

Twn/Rng- Section	N Lat. Deg.Min.	W Long Deg.Min.	Hole # Date	Collar Elev.	Bottom Temp. (°C)	Depth Interval (m)	Avg. TC $\text{Wm}^{-1}\text{K}^{-1}$	# TC	Uncorr. Gradient °C/km	Corr. Gradient °C/km	Corr. HF mWm^{-2}	Q HF
21S/ 3E- 35B2	43-42.50	122-25.50	DH-Z-8 11/25/75	459	10.33	55.0 63.0			12.7 1.1			X
22S/ 3E- 10DDC	43-40.26	122-27.04	PCCPG-WW 6/28/78	490	13.98	20.0 90.0	1.33	1	39.0 .6	40.0	53	B
22S/ 5E- 26BC	43-38.19	122-11.31	CR-MCHSW 9/29/76	975	15.32	30.0 150.0	1.97 .06	13	54.0 .4	51.8	102	B
23S/ 5E- 8DAA	43-35.48	122-14.02	PNTD CRK 8/ 1/80	1219	16.07	40.0 154.0	1.52 .04	4	83.3 3.3	66.1	101	B

The data fall into two groups: those east of the High Cascade-Western Cascade thermal boundary and those west of the boundary. West of the boundary, heat-flow values generally are below 55 mWm^{-2} , while east of the boundary they are generally above 100 mWm^{-2} (Blackwell and others, 1978). Typical gradients in the two areas are $25\text{-}35^{\circ}\text{C/km}$ and $60\text{-}70^{\circ}\text{C/km}$, respectively.

CONCLUSIONS AND RECOMMENDATIONS

Owing to the highly complex nature of the geology of the Willamette Pass, no preliminary geothermal model is presented with this report. Several areas, however, exhibit characteristics which appear to be favorable for geothermal development. They are the Eugene-Denio lineament, the Hills Creek Reservoir-Flat Creek shear zone, and the North Fork shear zone — a geophysical and geological lineament found at the northern boundary of the map. All of these areas show intense faulting and hydrothermal alteration, geophysical anomalies, and, in the case of the Eugene-Denio lineament, some indication of association with present-day active geothermal systems. Of the presently active geothermal systems, McCredie and Kitson Hot Springs are the most economically attractive for low-temperature exploitation, owing to their proximity to the city of Oakridge. Detailed study of these springs is recommended to assess their geothermal energy potential and to provide models for other Western Cascades thermal springs. To accomplish a detailed assessment of the geothermal resources, the following steps are recommended:

1. Detailed mapping (scale of 1:24,000 or greater) of the three major fault zones discussed above -- to identify and evaluate their relation to the geothermal systems.
2. Detailed spring and well sampling and analyses of both hot and cool waters, including isotopic and gas analyses -- to help evaluate precise reservoir conditions.
3. Closely spaced complete Bouguer and residual gravity anomaly studies along fault zones -- to further refine the gravity anomalies found during previous regional studies and to tie anomalies to mapped structures.
4. Resistivity traverses (either dipole-dipole, roving dipole, or telluric) across areas with thermal springs -- to further define the geothermal aquifers and locate areas of thermal upwelling and areas of recharge.

5. A program of ten to fifteen 500-ft gradient/stratigraphy holes, placed at strategic locations -- to complete the evaluation of the Willamette Pass geothermal model, with emphasis to be on detailed heat-flow modeling of thermal springs nearest to the city of Oakridge.
6. Six to eight 2,000-ft gradient/stratigraphy holes -- to evaluate thermal anomalies and directly test geothermal aquifers indicated by resistivity traverses and the shallow heat-flow study, with emphasis to be on areas nearest the city of Oakridge.

BIBLIOGRAPHY OF THE WILLAMETTE PASS AREA

- Allen, J.E., 1966, The Cascade Range volcano-tectonic depression of Oregon, in Transactions, Lunar Geological Field Conference, Bend, Oreg., August 1965: Oregon Department of Geology and Mineral Industries, p. 21-23.
- Armstrong, R.L., Taylor, E.M., Hales, P.O., and Parker, D.J., 1975, K-Ar dates for volcanic rocks, central Cascade Range of Oregon: Isochron/West, no. 13, p. 5-10.
- Ashwill, W.R., 1951, The geology of the Winberry Creek area, Lane County, Oregon: Eugene, Oreg., University of Oregon master's thesis, 63 p.
- Baldwin, E.M., 1976, Geology of Oregon (revised ed.): Dubuque, Iowa, Kendall/Hunt Publishing Co., 147 p.
- Bales, W.E., 1951, Geology of the lower Brice Creek area, Lane County, Oregon: Eugene, Oreg., University of Oregon master's thesis, 53 p.
- Barnes, C.G., and Ritchey, J.L., 1978, Tectonic implications of structural patterns in the Cascades of southern Oregon (abs): Proceedings of the Oregon Academy of Science, v. 14, p. 141-142.
- Beaulieu, J.D., 1971, Geologic formations of western Oregon (west of longitude 121° 30'): Oregon Department of Geology and Mineral Industries Bulletin 70, 72 p.
- Blackwell, D.D., 1969, Heat flow determinations in the northwestern United States: Journal of Geophysical Research, v. 74, no. 4, p. 997-1007.
- Blackwell, D.D., Hull, D.A., Bowen, R.G., and Steele, J.L., 1978, Heat flow of Oregon: Oregon Department of Geology and Mineral Industries Special Paper 4, 42 p.
- Blackwell, D.D., Steele, J.L., and Riccio, J.F., 1979, Heat flow of the Oregon Cascade Range (abs.): EOS (American Geophysical Union Transactions), v. 60, no. 46, p. 960.
- Bodvarsson, G., Couch, R.W., MacFarlane, W.T., Tank, R.W., and Whitsett, R.M., 1974, Telluric current exploration for geothermal anomalies in Oregon: Oregon Department of Geology and Mineral Industries, Ore Bin, v. 36, no. 6, p. 93-107.
- Bogue, R.G., and Hodge, E.T., 1940, Cascade andesites of Oregon: American Mineralogist, v. 25, no. 10, p. 627-665.
- Bowen, R.G., 1972, Geothermal gradient studies in Oregon: Oregon Department of Geology and Mineral Industries, Ore Bin, v. 34, no. 4, p. 68-71.
- _____, 1975, Geothermal gradient data: Oregon Department of Geology and Mineral Industries Open-File Report O-75-3, 133 p.

- Bowen, R.G., and Blackwell, D.D., 1973, Progress report on geothermal measurements in Oregon: Oregon Department of Geology and Mineral Industries, Ore Bin, v. 35, no. 1, p. 6-7.
- Bowen, R.G., Blackwell, D.D., and Hull, D.A., 1975, Geothermal studies and exploration in Oregon (draft final report to U.S. Bureau of Mines): Oregon Department of Geology and Mineral Industries Open-File Report 0-75-7, 65 p.
- _____, 1977, Geothermal exploration studies in Oregon: Oregon Department of Geology and Mineral Industries Miscellaneous Paper 19, 50 p.
- Bowen, R.G., and Peterson, N.V., compilers, 1970, Thermal springs and wells in Oregon: Oregon Department of Geology and Mineral Industries Miscellaneous Paper 14 (map), scale 1:1,000,000 (approx.).
- Bowen, R.G., Peterson, N.V., and Riccio, J.F., compilers, 1978, Low- to intermediate-temperature thermal springs and wells in Oregon: Oregon Department of Geology and Mineral Industries Geological Map Series GMS-10, scale 1:1,000,000.
- Brown, D.E., McLean, G.D., Gest, D.E., Woller, N.M., and Black, J.L., 1980, Reconnaissance geology of the Oakridge-Willamette Pass area, central Cascades, Oregon (abs.): Oregon Department of Geology and Mineral Industries, Oregon Geology, v. 42, no. 4, p. 69.
- Buddington, A.F., and Callaghan, E., 1936, Dioritic intrusive rocks and contact metamorphism in the Cascade Range in Oregon: American Journal of Science, 5th ser., v. 31, no. 186, p. 421-449.
- Callaghan, E., 1933, Some features of the volcanic sequence in the Cascade Range in Oregon: American Geophysical Union Transactions, 14 Annual Meeting, p. 243-249.
- _____, 1934, Some aspects of the geology of the Cascade Range in Oregon (abs.): Washington Academy of Science Journal, v. 24, no. 4, p. 190-191.
- Callaghan, E., and Buddington, A.F., 1938, Metalliferous mineral deposits of the Cascade Range in Oregon: U.S. Geological Survey Bulletin 893, 141 p.
- Connard, G.G., 1980, Analysis of aeromagnetic measurements from the central Oregon Cascades: Corvallis, Oreg., Oregon State University master's thesis, 101 p.
- Connard, G.G., Couch, R.W., and Gemperle, M., 1979, Regional tectonic and thermal model of the central Cascades, Oregon, from magnetic data (abs.): EOS (American Geophysical Union Transactions), v. 60, no. 46, p. 959.
- Connard, G.G., Gemperle, M., and Couch, R.W., 1978, A new aeromagnetic anomaly map of the central Cascades region of Oregon (abs.): EOS (American Geophysical Union Transactions), 25th Pacific Northwest Region Meeting, Tacoma, Wash. (unpublished).
- Couch, R.W., 1978, Geophysical investigations of the Cascade Range in central Oregon: U.S. Geological Survey Extramural Geothermal Research Program Technical Report 4 (unpublished), 133 p.

- Couch, R.W., and Baker, B., 1977, Geophysical investigations of the Cascade Range in central Oregon: U.S. Geological Survey Extramural Geothermal Research Program Technical Report 2 (unpublished), 55 p.
- Couch, R.W., Gemperle, M., and Connard, G.G., 1978, Total field aeromagnetic anomaly map, Cascade Mountain Range, central Oregon: Oregon Department of Geology and Mineral Industries Geological Map Series GMS-9, scale 1:125,000.
- Dickinson, W.R., 1979, Cenozoic plate tectonic setting of the Cordilleran region in the United States, *in* Armentrout, J.M., Cole, M.R., and Terbest, H., Jr., eds., Cenozoic paleogeography of the western United States: Pacific Coast Paleogeography Symposium 3, Anaheim, Calif., March 15-16, 1979, p. 219-237.
- Dole, H.M., ed., 1968, Andesite Conference guidebook: Oregon Department of Geology and Mineral Industries Bulletin 62, 107 p.
- Godwin, L.H., Haigler, L.B., Rioux, R.L., White, D.E., Muffler, L.J.P., and Wayland, R.G., 1971, Classification of public lands valuable for geothermal steam and associated geothermal resources: U.S. Geological Survey Circular 647, 18 p.
- Groh, E.A., 1966, Geothermal energy potential in Oregon: Oregon Department of Geology and Mineral Industries, Ore Bin, v. 28, no. 7, p. 125-135.
- Hammond, P.E., 1974, Brief outline to volcanic stratigraphy and guide to geology of southern Cascade Range, Washington, and northern Cascade Range, Oregon: Oregon Department of Geology and Mineral Industries unpublished report, 51 p.
- _____, 1976, Geothermal model for the Cascade Range: Oregon Department of Geology and Mineral Industries unpublished report, 20 p.
- _____, 1979, A tectonic model for evolution of the Cascade Range, *in* Armentrout, J.M., Cole, M.R., and Terbest, H., Jr., eds., Cenozoic paleogeography of the western United States: Pacific Coast Paleogeography Symposium 3, Anaheim, Calif., March 15-16, 1979, p. 219-237.
- Hodge, E.T., 1928, Framework of Cascade Mountains in Oregon: Pan-American Geologist, v. 49, no. 5, p. 341-356.
- Hull, D.A., Blackwell, D.D., and Black, G.L., 1978, Geothermal gradient data: Oregon Department of Geology and Mineral Industries Open-File Report 0-78-4, 187 p.
- Hull, D.A., Bowen, R.G., Blackwell, D.D., and Peterson, N.V., 1977, Preliminary heat-flow map and evaluation of Oregon's geothermal energy potential: Oregon Department of Geology and Mineral Industries, Ore Bin, v. 39, no. 7, p. 109-123.
- Kittleman, L.R., 1973, Mineralogy, correlation, and grain-size distributions of Mazama tephra and other postglacial pyroclastic layers, Pacific Northwest: Geological Society of America Bulletin, v. 84, no. 9, p. 2957-2980.

- Lawrence, R.D., 1976, Strike-slip faulting terminates the Basin and Range province in Oregon: Geological Society of America Bulletin, v. 87, no. 6, p. 846-850.
- Mackin, J.H., and Cary, A.S., 1965, Origin of Cascade landscapes: Washington Division of Mines and Geology Information Circular 41, 35 p.
- Mariner, R.H., Presser, T.S., Rapp, J.B., and Willey, L.M., 1975, The minor and trace elements, gas, and isotope compositions of the principal hot springs of Nevada and Oregon: U.S. Geological Survey open-file report, 27 p.
- Mariner, R.H., Rapp, J.B., Willey, L.M., and Presser, T.S., 1974, The chemical composition and estimated minimum thermal reservoir temperatures of selected hot springs in Oregon: Menlo Park, Calif., U.S. Geological Survey open-file report, 27 p.
- Mariner, R.H., Swanson, J.R., Orris, G.J., Presser, T.S., and Evans, W.C., 1980, Chemical and isotopic data for water from thermal springs and wells of Oregon: U.S. Geological Survey Open-File Report 80-737, 50 p.
- McBirney, A.R., 1968, Petrochemistry of the Cascade andesite volcanoes, in Dole, H.M., ed., Andesite Conference guidebook: Oregon Department of Geology and Mineral Industries Bulletin 62, p. 101-107.
- _____, 1975, Consequences of recent stratigraphic studies in the Oregon Cascade Range (abs.): Proceedings of the Oregon Academy of Science, v. 11, p. 83.
- _____, 1976, Some geologic constraints on models for magma generation in orogenic environments: Canadian Mineralogist, v. 14, no. 3, p. 245-254.
- McBirney, A.R., Sutter, J.F., Naslund, H.R., Sutton, K.G., and White, C.M., 1974, Episodic volcanism in the central Oregon Cascade Range: Geology, v. 2, no. 12, p. 585-589.
- McBirney, A.R., and White, C.M., 1977, Some quantitative aspects of orogenic volcanism in the Oregon Cascades (abs.): Geological Society of America Abstracts with Programs, v. 9, no. 7, p. 1087.
- _____, 1978, Recent progress in studies of the Oregon Cascades (abs.): Proceedings of the Oregon Academy of Science, v. 14, p. 157-158.
- Muffler, L.J.P., ed., 1979, Assessment of geothermal resources of the United States--1978: U.S. Geological Survey Circular 790, 163 p.
- Peck, D.L., Griggs, A.B., Schlicker, H.G., Wells, F.G., and Dole, H.M., 1964, Geology of the central and northern parts of the Western Cascade Range in Oregon: U.S. Geological Survey Professional Paper 449, 56 p.
- Peterson, N.V., and Groh, E.A., eds., 1965, Lunar Geological Field Conference guidebook: Oregon Department of Geology and Mineral Industries Bulletin 57, 51 p.

- Peterson, N.V., and Youngquist, W., 1975, Central Western and High Cascades geological reconnaissance and heat-flow hole location recommendations: Oregon Department of Geology and Mineral Industries Open-File Report 0-75-2, 41 p.
- Pitts, G.S., 1979, Interpretation of gravity measurements made in the Cascade Mountains and the adjoining Basin and Range province in central Oregon: Corvallis, Oreg., Oregon State University master's thesis, 186 p.
- Pitts, G.S., Connard, G.G., Gemperle, M., and Couch, R.W., 1978, Gravity and aeromagnetic measurements in the central Cascades of Oregon (abs.): EOS (American Geophysical Union Transactions), v. 59, no. 12, p. 1188-1189.
- Pitts, G.S., and Couch, R.W., 1978, Complete Bouguer gravity anomaly map, Cascade Mountain Range, central Oregon: Oregon Department of Geology and Mineral Industries Geological Map Series GMS-8, scale 1:125,000.
- Riccio, J.F., compiler, 1979, Preliminary geothermal resource map of Oregon: Oregon Department of Geology and Mineral Industries Geological Map Series GMS-11, scale 1:500,000.
- _____, 1980, Geothermal exploration in Oregon, 1979: Oregon Department of Geology and Mineral Industries, Oregon Geology, v. 42, no. 4, p. 59-69.
- Riccio, J.F., and Newton, V.C., Jr., 1979, Geothermal exploration in Oregon in 1978: Oregon Department of Geology and Mineral Industries, Oregon Geology, v. 41, no. 3, p. 39-46.
- Sass, J.H., Lachenbruch, A.H., Munroe, R.J., Green, G.W., and Moses, T.H., Jr., 1971, Heat flow in the western United States: Journal of Geophysical Research, v. 76, no. 26, p. 6376-6413.
- Schlicker, H.G., and Dole, H.M., 1957, Reconnaissance geology of the Marcola, Leaburg, and Lowell quadrangles, Oregon: Oregon Department of Geology and Mineral Industries, Ore Bin, v. 19, no. 7, p. 57-62.
- Shannon and Wilson, Inc., 1970, Private report to Stone and Webster Engineering Corp. on preliminary subsurface investigation of proposed nuclear power plant sites for Eugene Water and Electric Board, Eugene, Oregon.
- Sutter, J.F., 1978, K/Ar ages of Cenozoic volcanic rocks from the Oregon Cascades west of 121° 30': Isochron/West, no. 21, p. 15-31.
- Taylor, H.P., 1971, Oxygen isotope evidence for large-scale interaction between meteoric groundwaters and Tertiary granodiorite intrusions, Western Cascade Range, Oregon: Journal of Geophysical Research, v. 76, p. 7855-7874.
- Thayer, T.P., 1937, Petrology of later Tertiary and Quaternary rocks of the north-central Cascade Mountains in Oregon, with notes on similar rocks in western Nevada: Geological Society of America Bulletin, v. 48, no. 11, p. 1611-1651.

- Thiruvathukal, J.V., 1968, Regional gravity of Oregon: Corvallis, Oreg., Oregon State University doctoral dissertation, 92 p.
- U.S. Geological Survey and Oregon Department of Geology and Mineral Industries, 1979, Chemical analyses of thermal springs and wells in Oregon: Oregon Department of Geology and Mineral Industries Open-File Report O-79-3, 170 p.
- Wells, F.G., and Peck, D.L., 1961, Geologic map of Oregon west of the 121st meridian: U.S. Geological Survey Miscellaneous Geologic Investigations Map I-325, scale 1:500,000.
- Wheeler, H.E., and Mallory, V.S., 1970, Oregon Cascades in relation to Cenozoic stratigraphy, in Columbia River Basalt Symposium, 2nd, Cheney, Wash., 1969, Proceedings: Cheney, Wash., Eastern Washington State College Press, p. 97-124.
- Wilkinson, W.D., and Schlicker, H.G., 1959, Field trip 3 (Corvallis to Prineville), in Field guidebook, College Teachers Conference in Geology, Corvallis, Oreg., 1959: Oregon Department of Geology and Mineral Industries Bulletin 50, p. 43-72.
- Williams, H., 1953, The ancient volcanoes of Oregon (2nd ed.): Eugene, Oreg., Oregon State System of Higher Education, Condon Lectures, 68 p.

APPENDIX A

Formulas used in calculations

Na:K (revised):
$$t^{\circ}\text{C} = \frac{1217}{\log (\text{Na}/\text{K}) + 1.483} - 273.15 \text{ (Fournier, 1979)}$$

Na:K:Ca:
$$t^{\circ}\text{C} = \frac{1647}{2.24 + F (T)} - 273.15 \text{ (Fournier and Truesdell, 1973),}$$

where $F (T) = \log (\text{Na}/\text{K}) + [\beta \log (\sqrt{\text{Ca}}/\text{Na})]$,
 $\beta = 1/3$ if $t > 100^{\circ}\text{C}$, and $4/3$ if $t < 100^{\circ}\text{C}$,
 $t^{\circ}\text{C}$ = calculated reservoir temperature,
and concentrations are expressed in molality.

Magnesium correction ratio:

$$R = \frac{(\text{milliequivalents Mg})}{(\text{milliequivalents Mg}) + (\text{milliequivalents Ca}) + (\text{milliequivalents K})} \times 100$$

If $R < 5$ or > 50 , no calculation was made. For R between 5-50,

$$\Delta t_{\text{Mg}} = 10.66 - (4.7415) (R) + [(325.87) (\log R)^2] - [(1.032 \times 10^5) (\log R)^2/T] - [(1.968 \times 10^7) (\log R)^2/T^2] + [(1.605 \times 10^7) (\log R)^3/T^2],$$

where R = magnesium correction ratio expressed in equivalents,

Δt_{Mg} = the temperature correction that is subtracted from
the Na:K:Ca $1/3 \beta$ calculated temperature,

T = Na:K:Ca $1/3 \beta$ calculated temperature in $^{\circ}\text{K}$.

Or Δt_{Mg} can be obtained by using the graph compiled by Fournier and Potter (1979).

SiO_2 temperature calculations (Fournier and Rowe, 1966):

SiO_2 (conductive),
$$t^{\circ}\text{C} = \frac{1309}{5.19 + \log (\text{SiO}_2)} - 273.15$$

SiO_2 (adiabatic),
$$t^{\circ}\text{C} = \frac{1522}{5.75 + \log (\text{SiO}_2)} - 273.15$$

SiO_2 (chalcedony),
$$t^{\circ}\text{C} = \frac{1032}{4.69 + \log (\text{SiO}_2)} - 273.15$$

SiO_2 (opal),
$$t^{\circ}\text{C} = \frac{731}{4.52 + \log (\text{SiO}_2)} - 273.15,$$

where SiO_2 is expressed in mg/l.

References cited:

- Fournier, R.O., 1979, A revised equation for the Na/K geothermometer, in Geothermal Resources Council Transactions 3, 1979, p. 221-224.
- Fournier, R.O., and Potter, R.W., II, 1979, Magnesium correction to the Na:K:Ca chemical geothermometer: *Geochimica et Cosmochimica Acta*, v. 43, p. 1543-1550.
- Fournier, R.O., and Rowe, J.J., 1966, Estimation of underground temperatures from the silica content of water from hot springs and wet-steam wells: *American Journal of Science*, v. 264, p. 685-697.
- Fournier, R.O., and Truesdell, A.H., 1973, An empirical Na:K:Ca geothermometer for natural waters: *Geochimica et Cosmochimica Acta*, v. 37, p. 1255-1275.
- Mariner, R.H., Swanson, J.R., Orris, G.J., Presser, T.S., and Evans, W.C., 1980, Chemical and isotopic data for water from thermal springs and wells of Oregon: U.S. Geological Survey Open-File Report 80-737, 50 p.

LOCATION: ROSEBURG AMS, OREGON

19S/ 4E-29CCB

HOLE NAME: CHRS CRK

DATE MEASURED: 9/17/80

DEPTH METERS	DEPTH FEET	TEMPERATURE		GEOTHERMAL GRADIENT	
		DEG C	DEG F	DEG C/KM	DEG F/100 FT
15.0	49.2	8.860	47.95	0.0	0.0
17.0	55.8	8.920	48.05	30.0	1.6
19.0	62.3	8.950	48.11	15.0	0.8
21.0	68.9	9.030	48.25	40.0	2.2
23.0	75.4	9.100	48.38	35.0	1.9
25.0	82.0	9.160	48.49	30.0	1.6
27.0	88.6	9.300	48.74	70.0	3.8
29.0	95.1	9.520	49.14	110.0	6.0
31.0	101.7	9.670	49.41	75.0	4.1
33.0	108.2	9.870	49.77	100.0	5.5
35.0	114.8	9.930	49.87	30.0	1.6
37.0	121.4	9.940	49.89	5.0	0.3
39.0	127.9	9.990	49.98	25.0	1.4
41.0	134.5	10.020	50.04	15.0	0.8
43.0	141.0	10.050	50.09	15.0	0.8
45.0	147.6	10.080	50.14	15.0	0.8
47.0	154.2	10.120	50.22	20.0	1.1
49.0	160.7	10.180	50.32	30.0	1.6
51.0	167.3	10.400	50.72	110.0	6.0
53.0	173.8	10.780	51.40	190.0	10.4
55.0	180.4	10.930	51.67	75.0	4.1
57.0	187.0	10.980	51.76	25.0	1.4
59.0	193.5	11.030	51.85	25.0	1.4
61.0	200.1	11.050	51.89	10.0	0.5
63.0	206.6	11.070	51.93	10.0	0.5
65.0	213.2	11.080	51.94	5.0	0.3
67.0	219.8	11.150	52.07	35.0	1.9
69.0	226.3	11.390	52.50	120.0	6.6
71.0	232.9	11.560	52.81	85.0	4.7
73.0	239.4	11.710	53.08	75.0	4.1
75.0	246.0	11.840	53.31	65.0	3.6
77.0	252.6	11.960	53.53	60.0	3.3
79.0	259.1	12.070	53.73	55.0	3.0
81.0	265.7	12.210	53.98	70.0	3.8
83.0	272.2	12.330	54.19	60.0	3.3
85.0	278.8	12.450	54.41	60.0	3.3
87.0	285.4	12.580	54.64	65.0	3.6
89.0	291.9	12.700	54.86	60.0	3.3
91.0	298.5	12.830	55.09	65.0	3.6
93.0	305.0	12.930	55.27	50.0	2.7
95.0	311.6	13.060	55.51	65.0	3.6

Geothermal - gradient data

APPENDIX B

LOCATION: ROSEBURG AMS, OREGON

PAGE 2

19S/ 4E-29CCB

HOLE NAME: CHRS CRK

DATE MEASURED: 9/17/80

DEPTH METERS	DEPTH FEET	TEMPERATURE		GEOTHERMAL GRADIENT	
		DEG C	DEG F	DEG C/KM	DEG F/100 FT
97.0	318.2	13.190	55.74	65.0	3.6
99.0	324.7	13.320	55.98	65.0	3.6
101.0	331.3	13.440	56.19	60.0	3.3
103.0	337.8	13.580	56.44	70.0	3.8
105.0	344.4	13.690	56.64	55.0	3.0
107.0	351.0	13.820	56.88	65.0	3.6
109.0	357.5	13.980	57.16	80.0	4.4
111.0	364.1	14.110	57.40	65.0	3.6
113.0	370.6	14.250	57.65	70.0	3.8
115.0	377.2	14.390	57.90	70.0	3.8
117.0	383.8	14.520	58.14	65.0	3.6
119.0	390.3	14.650	58.37	65.0	3.6
121.0	396.9	14.780	58.60	65.0	3.6
123.0	403.4	14.930	58.87	75.0	4.1
125.0	410.0	15.040	59.07	55.0	3.0
127.0	416.6	15.180	59.32	70.0	3.8
129.0	423.1	15.310	59.56	65.0	3.6
131.0	429.7	15.430	59.77	60.0	3.3
133.0	436.2	15.570	60.03	70.0	3.8
135.0	442.8	15.730	60.31	80.0	4.4
137.0	449.4	15.860	60.55	65.0	3.6
139.0	455.9	15.980	60.76	60.0	3.3
141.0	462.5	16.100	60.98	60.0	3.3
143.0	469.0	16.210	61.18	55.0	3.0
145.0	475.6	16.320	61.38	55.0	3.0
147.0	482.2	16.430	61.57	55.0	3.0
149.0	488.7	16.540	61.77	55.0	3.0
151.0	495.3	16.660	61.99	60.0	3.3
153.0	501.8	16.760	62.17	50.0	2.7

TEMPERATURE, DEG C

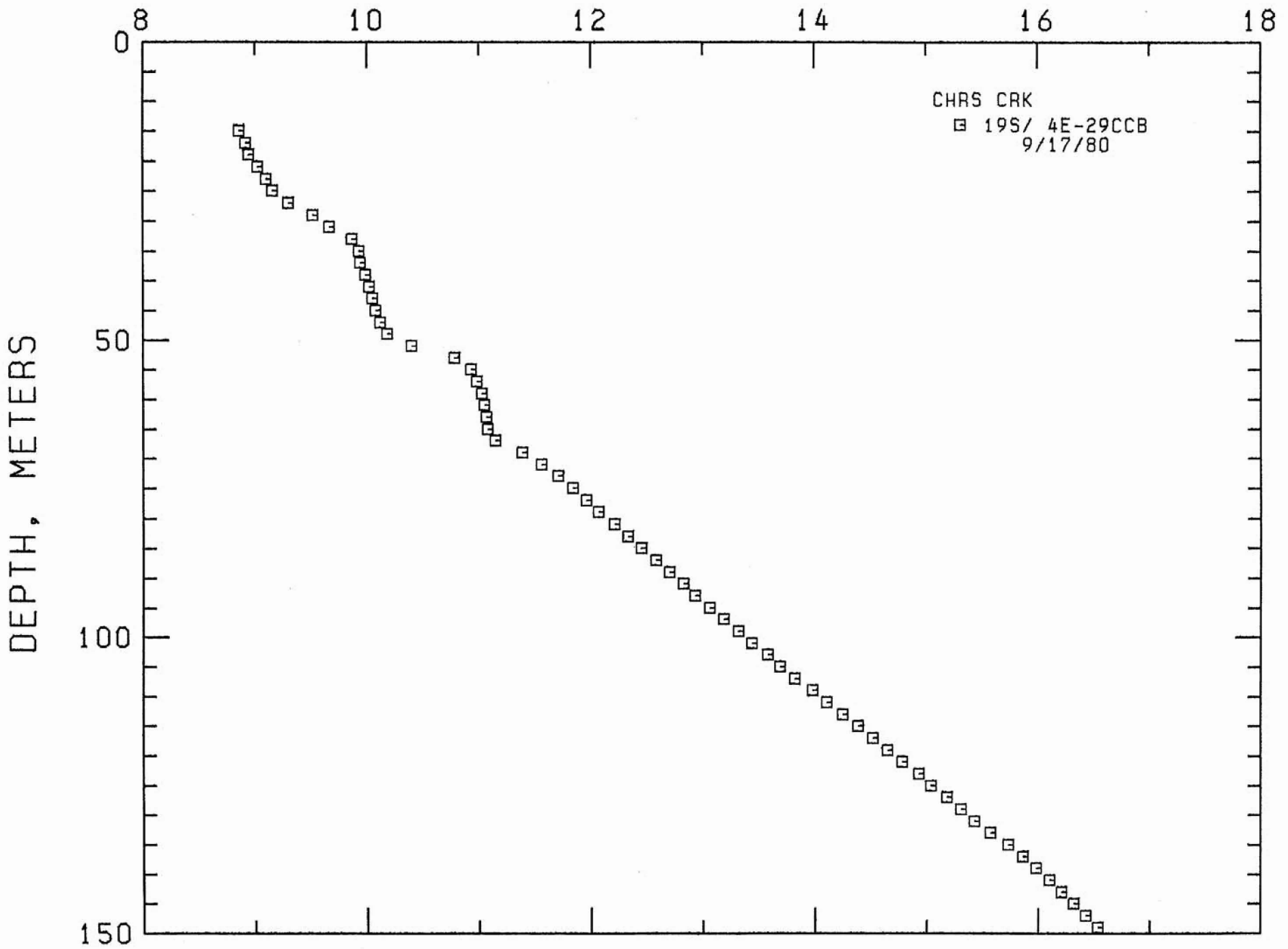

LOCATION: ROSEBURG AMS, OREGON

19S/ SE-27BCC

HOLE NAME: BRCK CRK

DATE MEASURED: 9/17/80

DEPTH METERS	DEPTH FEET	TEMPERATURE		GEOTHERMAL GRADIENT	
		DEG C	DEG F	DEG C/KM	DEG F/100 FT
30.0	98.4	11.110	52.00	0.0	0.0
32.0	105.0	9.600	49.28	-755.0	-41.4
34.0	111.5	9.650	49.37	25.0	1.4
36.0	118.1	9.680	49.42	15.0	0.8
38.0	124.6	9.700	49.46	10.0	0.5
40.0	131.2	9.710	49.48	5.0	0.3
42.0	137.8	9.710	49.48	0.0	0.0
44.0	144.3	9.740	49.53	15.0	0.8
46.0	150.9	9.820	49.68	40.0	2.2
48.0	157.4	9.850	49.73	15.0	0.8
50.0	164.0	9.950	49.91	50.0	2.7
52.0	170.6	9.980	49.96	15.0	0.8
54.0	177.1	10.020	50.04	20.0	1.1
56.0	183.7	10.040	50.07	10.0	0.5
58.0	190.2	10.060	50.11	10.0	0.5
60.0	196.8	10.130	50.23	35.0	1.9
62.0	203.4	10.230	50.41	50.0	2.7
64.0	209.9	10.310	50.56	40.0	2.2
66.0	216.5	10.310	50.56	0.0	0.0
68.0	223.0	10.430	50.77	60.0	3.3
70.0	229.6	10.450	50.81	10.0	0.5
72.0	236.2	10.530	50.95	40.0	2.2
74.0	242.7	10.640	51.15	55.0	3.0
76.0	249.3	10.800	51.44	80.0	4.4
78.0	255.8	11.290	52.32	245.0	13.4
80.0	262.4	11.580	52.84	145.0	8.0
82.0	269.0	11.610	52.90	15.0	0.8
84.0	275.5	11.630	52.93	10.0	0.5
86.0	282.1	11.640	52.95	5.0	0.3
88.0	288.6	11.640	52.95	0.0	0.0
90.0	295.2	11.700	53.06	30.0	1.6
92.0	301.8	11.720	53.10	10.0	0.5
94.0	308.3	11.740	53.13	10.0	0.5
96.0	314.9	11.760	53.17	10.0	0.5
98.0	321.4	11.790	53.22	15.0	0.8
100.0	328.0	11.860	53.35	35.0	1.9
102.0	334.6	11.910	53.44	25.0	1.4
104.0	341.1	11.970	53.55	30.0	1.6
106.0	347.7	11.990	53.58	10.0	0.5
108.0	354.2	11.970	53.55	-10.0	-0.5
110.0	360.8	12.010	53.62	20.0	1.1

LOCATION: ROSEBURG AMS, OREGON

PAGE 2

19S/ 5E-27BCC

HOLE NAME: BRCK CRK

DATE MEASURED: 9/17/80

DEPTH METERS	DEPTH FEET	TEMPERATURE		GEOTHERMAL GRADIENT	
		DEG C	DEG F	DEG C/KM	DEG F/100 FT
112.0	367.4	12.070	53.73	30.0	1.6
114.0	373.9	12.100	53.78	15.0	0.8
116.0	380.5	12.120	53.82	10.0	0.5
118.0	387.0	12.400	54.32	140.0	7.7
120.0	393.6	12.870	55.17	235.0	12.9
122.0	400.2	13.310	55.96	220.0	12.1
124.0	406.7	13.640	56.55	165.0	9.1
126.0	413.2	13.920	57.06	140.0	7.7
128.0	419.8	14.210	57.58	145.0	8.0
130.0	426.4	14.430	57.97	110.0	6.0
132.0	433.0	14.620	58.32	95.0	5.2
134.0	439.5	14.800	58.64	90.0	4.9
136.0	446.1	14.940	58.89	70.0	3.8
138.0	452.6	15.070	59.13	65.0	3.6
140.0	459.2	15.200	59.36	65.0	3.6
142.0	465.8	15.360	59.65	80.0	4.4
144.0	472.3	15.460	59.83	50.0	2.7
146.0	478.9	15.550	59.99	45.0	2.5
148.0	485.4	15.740	60.33	95.0	5.2
150.0	492.0	15.940	60.69	100.0	5.5
152.0	498.6	16.060	60.91	60.0	3.3

TEMPERATURE, DEG C

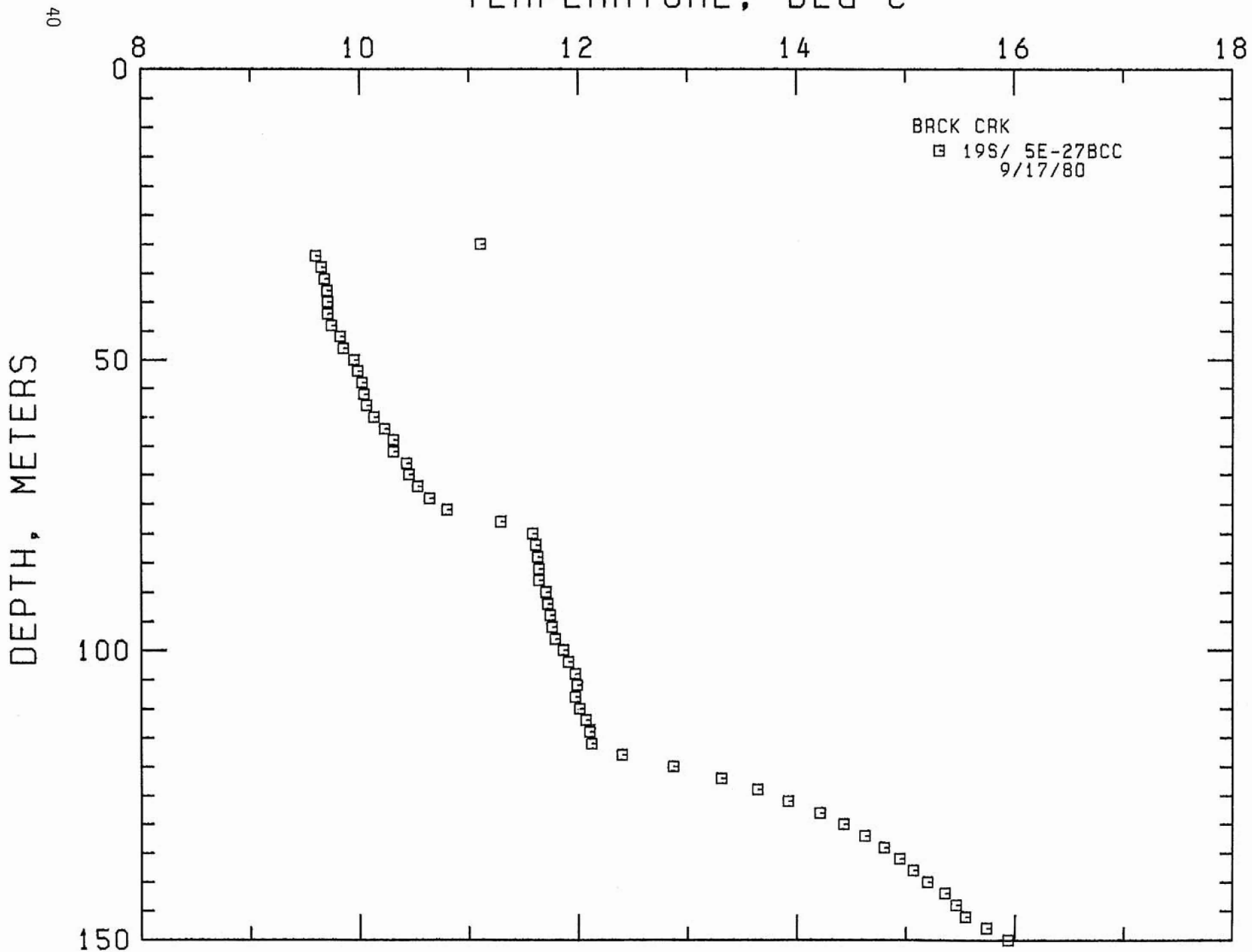

LOCATION: ROSEBURG AMS, OREGON

19S/ 6E-25DCD

HOLE NAME: N FORK

DATE MEASURED: 9/17/80

DEPTH METERS	DEPTH FEET	TEMPERATURE		GEOTHERMAL GRADIENT	
		DEG C	DEG F	DEG C/KM	DEG F/100 FT
36.0	118.1	10.300	50.54	0.0	0.0
38.0	124.6	10.040	50.07	-130.0	-7.1
40.0	131.2	10.210	50.38	85.0	4.7
42.0	137.8	10.270	50.49	30.0	1.6
44.0	144.3	10.380	50.68	55.0	3.0
46.0	150.9	10.520	50.94	70.0	3.8
48.0	157.4	10.630	51.13	55.0	3.0
50.0	164.0	10.740	51.33	55.0	3.0
52.0	170.6	10.840	51.51	50.0	2.7
54.0	177.1	10.980	51.76	70.0	3.8
56.0	183.7	11.150	52.07	85.0	4.7
58.0	190.2	11.290	52.32	70.0	3.8
60.0	196.8	11.440	52.59	75.0	4.1
62.0	203.4	11.610	52.90	85.0	4.7
64.0	209.9	11.760	53.17	75.0	4.1
66.0	216.5	11.910	53.44	75.0	4.1
68.0	223.0	12.060	53.71	75.0	4.1
70.0	229.6	12.220	54.00	80.0	4.4
72.0	236.2	12.350	54.23	65.0	3.6
74.0	242.7	12.520	54.54	85.0	4.7
76.0	249.3	12.660	54.79	70.0	3.8
78.0	255.8	12.780	55.00	60.0	3.3
80.0	262.4	12.880	55.18	50.0	2.7
82.0	269.0	12.980	55.36	50.0	2.7
84.0	275.5	13.090	55.56	55.0	3.0
86.0	282.1	13.210	55.78	60.0	3.3
88.0	288.6	13.310	55.96	50.0	2.7
90.0	295.2	13.410	56.14	50.0	2.7
92.0	301.8	13.500	56.30	45.0	2.5
94.0	308.3	13.650	56.57	75.0	4.1
96.0	314.9	13.740	56.73	45.0	2.5
98.0	321.4	13.850	56.93	55.0	3.0
100.0	328.0	14.000	57.20	75.0	4.1
102.0	334.6	14.110	57.40	55.0	3.0
104.0	341.1	14.270	57.69	80.0	4.4
106.0	347.7	14.380	57.88	55.0	3.0
108.0	354.2	14.540	58.17	80.0	4.4
110.0	360.8	14.700	58.46	80.0	4.4
112.0	367.4	14.820	58.68	60.0	3.3
114.0	373.9	14.980	58.96	80.0	4.4
116.0	380.5	15.150	59.27	85.0	4.7

LOCATION: ROSEBURG AMS, OREGON

PAGE 2

19S/ 6E-25DCD

HOLE NAME: N FORK

DATE MEASURED: 9/17/80

DEPTH METERS	DEPTH FEET	TEMPERATURE		GEOTHERMAL GRADIENT	
		DEG C	DEG F	DEG C/KM	DEG F/100 FT
118.0	387.0	15.360	59.65	105.0	5.8
120.0	393.6	15.550	59.99	95.0	5.2
122.0	400.2	15.790	60.42	120.0	6.6
124.0	406.7	15.980	60.76	95.0	5.2
126.0	413.3	16.190	61.14	105.0	5.8
128.0	419.8	16.350	61.43	80.0	4.4
130.0	426.4	16.520	61.74	85.0	4.7
132.0	433.0	16.700	62.06	90.0	4.9
134.0	439.5	16.880	62.38	90.0	4.9
136.0	446.1	17.050	62.69	85.0	4.7
138.0	452.6	17.220	63.00	85.0	4.7
140.0	459.2	17.410	63.34	95.0	5.2
142.0	465.8	17.600	63.68	95.0	5.2
144.0	472.3	17.750	63.95	75.0	4.1
146.0	478.9	17.910	64.24	80.0	4.4
148.0	485.4	18.070	64.53	80.0	4.4
150.0	492.0	18.190	64.74	60.0	3.3
152.0	498.6	18.510	65.32	160.0	8.8

TEMPERATURE, DEG C

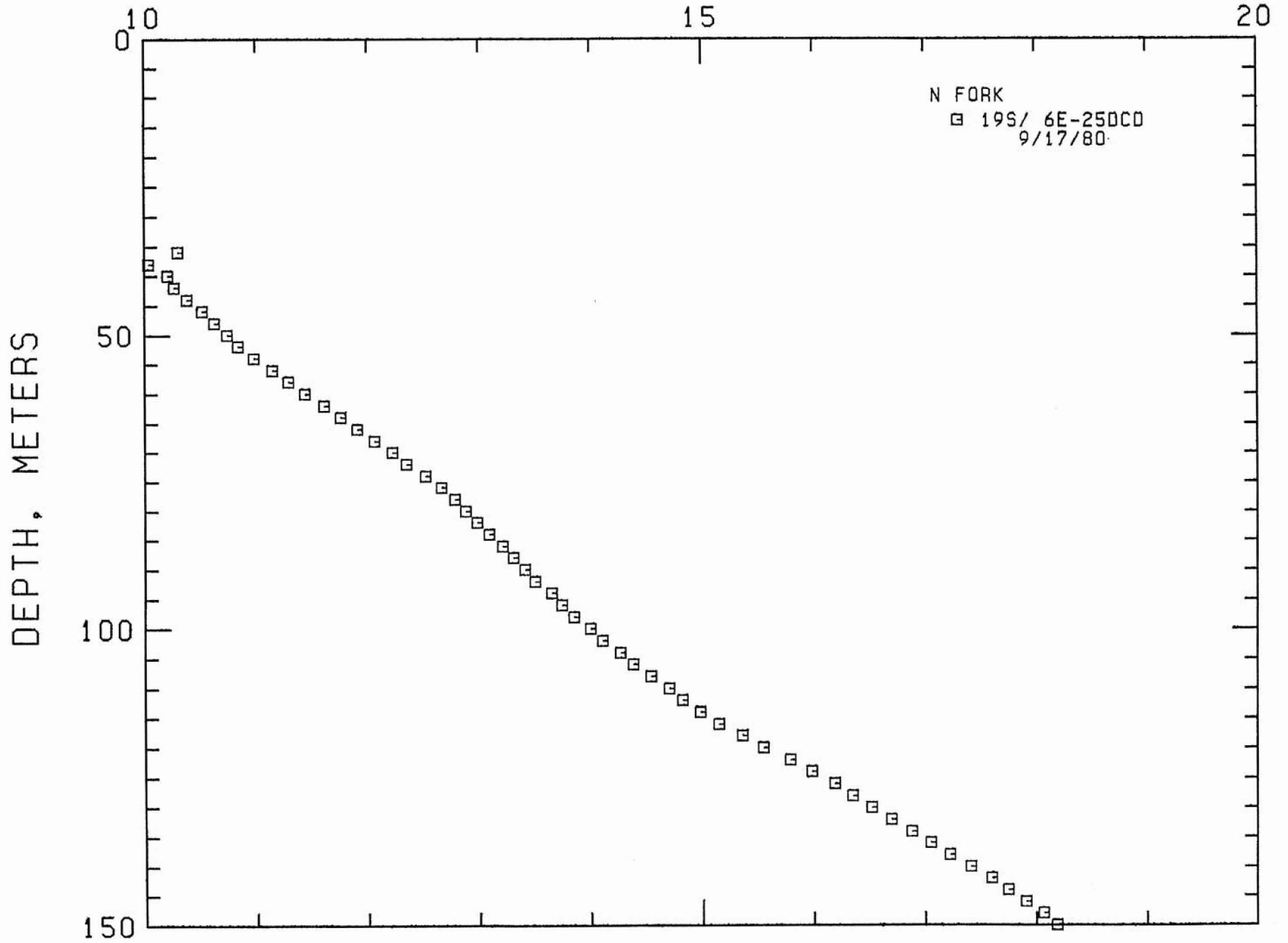

LOCATION: ROSEBURG AMS, OREGON
 205/ 3E-26DA
 HOLE NUMBER: CS-144
 DATE MEASURED: 9/28/76

DEPTH METERS	DEPTH FEET	TEMPERATURE		GEOHERMAL GRADIENT	
		DEG C	DEG F	DEG C/KM	DEG F/100 FT
20.0	65.6	9.020	48.24	0.0	0.0
30.0	98.4	9.110	48.40	9.0	0.5
40.0	131.2	9.400	48.92	29.0	1.6
45.0	147.6	9.510	49.12	22.0	1.2
50.0	164.0	9.570	49.23	12.0	0.7
55.0	180.4	9.680	49.42	22.0	1.2
60.0	196.8	9.810	49.66	26.0	1.4
65.0	213.2	9.940	49.89	26.0	1.4
70.0	229.6	10.090	50.14	28.0	1.5
75.0	246.0	10.250	50.45	34.0	1.9
80.0	262.4	10.430	50.77	36.0	2.0
85.0	278.8	10.620	51.12	38.0	2.1
90.0	295.2	10.800	51.44	36.0	2.0
95.0	311.6	10.960	51.73	32.0	1.8
100.0	328.0	11.140	52.05	36.0	2.0
105.0	344.4	11.330	52.39	38.0	2.1
110.0	360.8	11.530	52.75	40.0	2.2
115.0	377.2	11.770	53.19	48.0	2.6
120.0	393.6	12.000	53.60	46.0	2.5
125.0	410.0	12.190	53.94	38.0	2.1
130.0	426.4	12.390	54.30	40.0	2.2
135.0	442.8	12.590	54.66	40.0	2.2
140.0	459.2	12.660	54.79	52.0	2.9

TEMPERATURE, DEG C

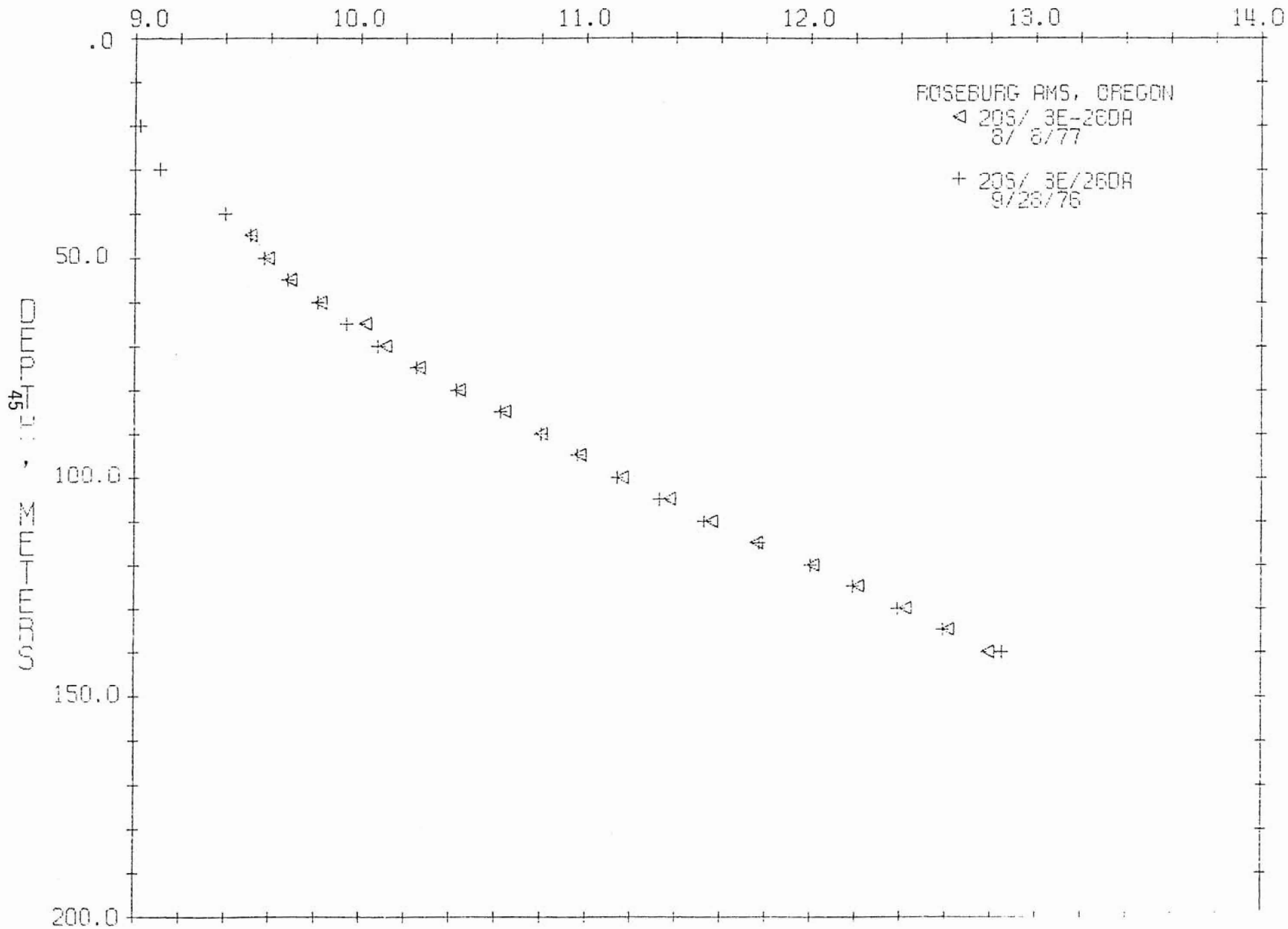

TEMPERATURE, DEG C

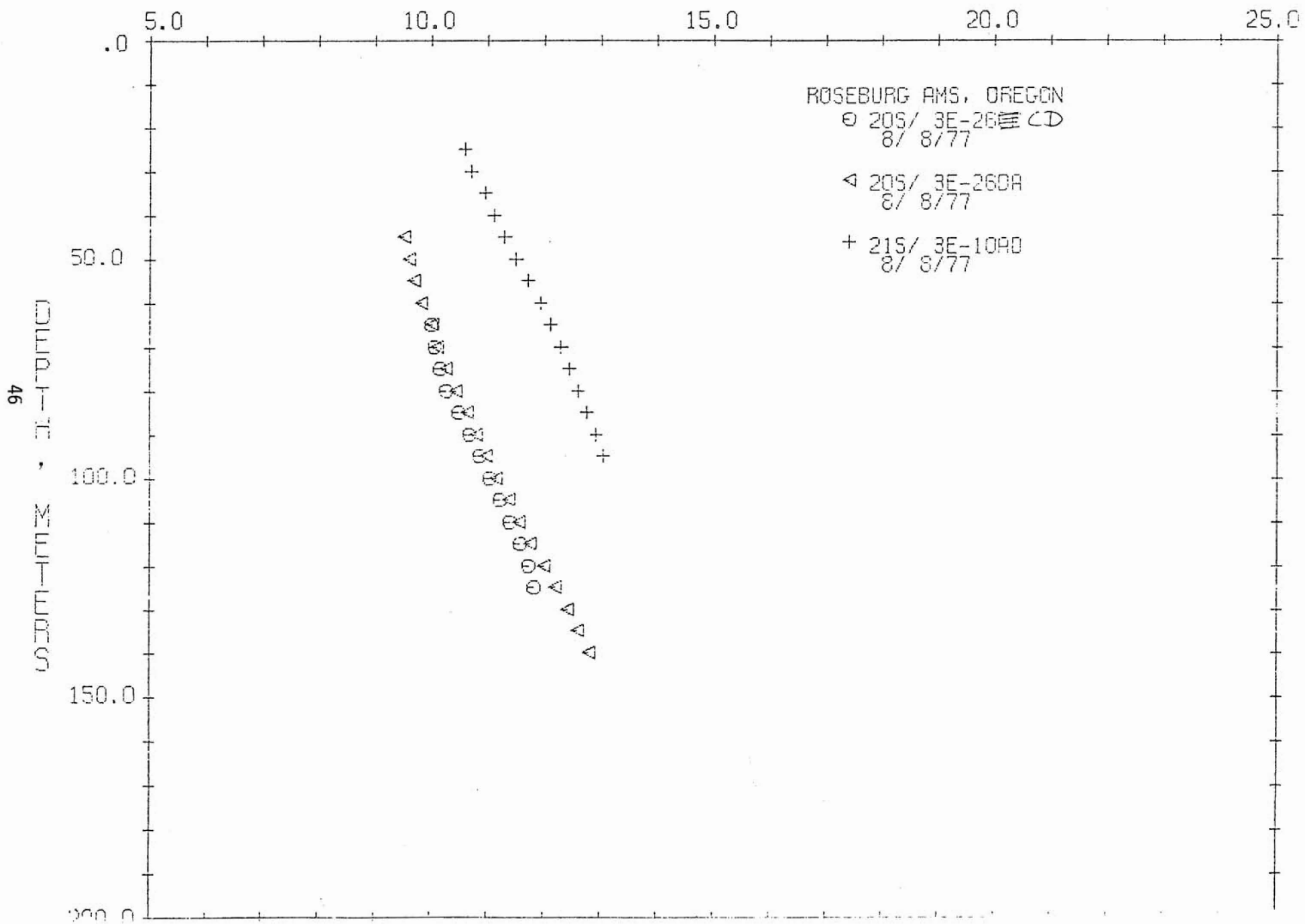

LOCATION: ROSEBURG AMS, OREGON

20S/ 4E-27DDD

HOLE NAME: WALL CRK

DATE MEASURED: 9/17/80

DEPTH METERS	DEPTH FEET	TEMPERATURE		GEOTHERMAL GRADIENT	
		DEG C	DEG F	DEG C/KM	DEG F/100 FT
8.0	26.2	8.980	48.16	0.0	0.0
10.0	32.8	8.800	47.84	-20.0	-4.9
12.0	39.4	8.840	47.91	20.0	1.1
14.0	45.9	8.880	47.98	20.0	1.1
16.0	52.5	8.930	48.07	25.0	1.4
18.0	59.0	9.020	48.24	45.0	2.5
20.0	65.6	9.160	48.49	70.0	3.8
22.0	72.2	9.330	48.79	85.0	4.7
24.0	78.7	9.420	48.96	45.0	2.5
26.0	85.3	9.650	49.37	115.0	6.3
28.0	91.8	9.690	49.44	20.0	1.1
30.0	98.4	9.740	49.53	25.0	1.4
32.0	105.0	10.070	50.13	165.0	9.1
34.0	111.5	10.290	50.52	110.0	6.0
36.0	118.1	10.490	50.88	100.0	5.5
38.0	124.6	10.700	51.26	105.0	5.8
40.0	131.2	11.020	51.84	160.0	8.8
42.0	137.8	11.140	52.05	60.0	2.6
44.0	144.3	11.180	52.12	20.0	1.1
46.0	150.9	11.280	52.30	50.0	2.7
48.0	157.4	11.400	52.52	50.0	2.6
50.0	164.0	11.530	52.75	65.0	3.6
52.0	170.6	11.660	52.99	65.0	3.6
54.0	177.1	11.790	53.22	65.0	3.6
56.0	183.7	11.910	53.44	60.0	3.3
58.0	190.2	12.040	53.67	65.0	3.6
60.0	196.8	12.160	53.89	60.0	3.3
62.0	203.4	12.250	54.05	45.0	2.2
64.0	209.9	12.300	54.14	25.0	1.4
66.0	216.5	12.510	54.52	105.0	5.8
68.0	223.0	12.760	54.97	125.0	6.9
70.0	229.6	12.910	55.24	75.0	4.1
72.0	236.2	13.070	55.53	80.0	4.4
74.0	242.7	13.190	55.74	60.0	3.3
76.0	249.3	13.330	55.99	70.0	3.8
78.0	255.8	13.470	56.25	70.0	3.8
80.0	262.4	13.610	56.50	70.0	3.8
82.0	269.0	13.760	56.77	75.0	4.1
84.0	275.5	13.900	57.02	70.0	3.8
86.0	282.1	14.050	57.29	75.0	4.1
88.0	288.6	14.200	57.56	75.0	4.1

LOCATION: ROSEBURG AMS, OREGON

PAGE 2

20S/ 4E-27DDD

HOLE NAME: WALL CRK

DATE MEASURED: 9/17/80

DEPTH METERS	DEPTH FEET	TEMPERATURE		GEOTHERMAL GRADIENT	
		DEG C	DEG F	DEG C/KM	DEG F/100 FT
90.0	295.2	14.360	57.85	80.0	4.4
92.0	301.8	14.510	58.12	75.0	4.1
94.0	308.3	14.650	58.37	70.0	3.8
96.0	314.9	14.790	58.62	70.0	3.8
98.0	321.4	14.940	58.89	75.0	4.1
100.0	328.0	15.080	59.14	70.0	3.8
102.0	334.6	15.230	59.41	75.0	4.1
104.0	341.1	15.370	59.67	70.0	3.8
106.0	347.7	15.520	59.94	75.0	4.1
108.0	354.2	15.680	60.22	80.0	4.4
110.0	360.8	15.830	60.49	75.0	4.1
112.0	367.4	15.970	60.75	70.0	3.8
114.0	373.9	16.120	61.02	75.0	4.1
116.0	380.5	16.280	61.30	80.0	4.4
118.0	387.0	16.430	61.57	75.0	4.1
120.0	393.6	16.570	61.83	70.0	3.8
122.0	400.2	16.720	62.10	75.0	4.1
124.0	406.7	16.860	62.35	70.0	3.8
126.0	413.3	17.020	62.64	80.0	4.4
128.0	419.8	17.190	62.94	85.0	4.7
130.0	426.4	17.330	63.19	70.0	3.8
132.0	433.0	17.510	63.52	90.0	4.9
134.0	439.5	17.650	63.77	70.0	3.8

TEMPERATURE, DEG C

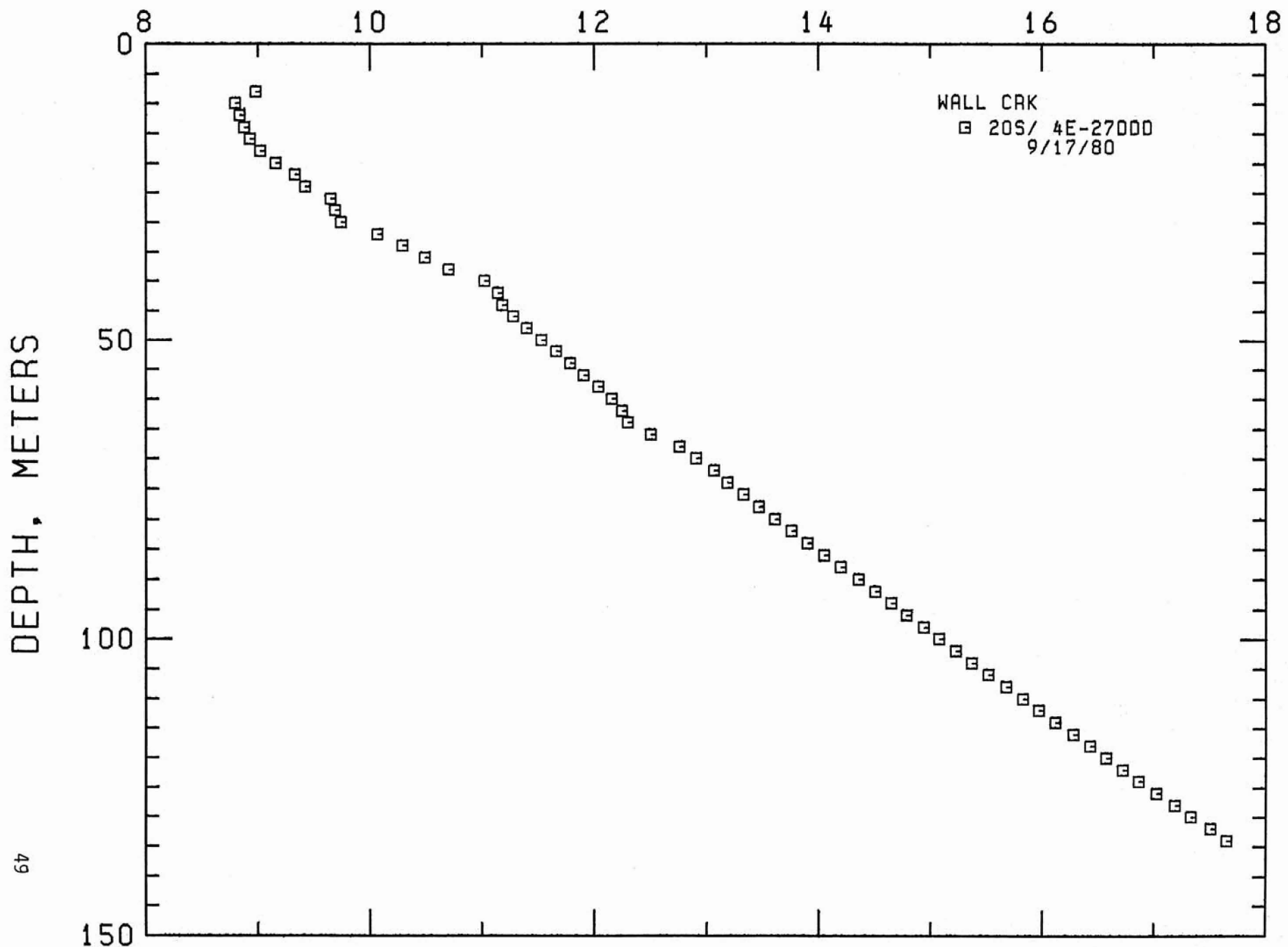

LOCATION: ROSEBURG AMS, OREGON
 205/ 3E-26CD
 HOLE NUMBER: AE-111
 DATE MEASURED: 8/ 8/77

DEPTH METERS	DEPTH FEET	TEMPERATURE		GEOHERMAL GRADIENT	
		DEG C	DEG F	DEG C/KM	DEG F/100 FT
65.0	213.2	10.010	50.02	0.0	0.0
70.0	229.6	10.050	50.11	10.0	0.5
75.0	246.0	10.150	50.29	20.0	1.1
80.0	262.4	10.270	50.49	22.0	1.2
85.0	278.8	10.430	50.78	44.0	2.4
90.0	295.2	10.630	51.32	38.0	2.1
95.0	311.6	10.850	51.53	35.0	2.0
100.0	328.0	11.040	51.87	35.0	2.0
105.0	344.4	11.230	52.20	35.0	2.0
110.0	360.8	11.330	52.39	34.0	1.9
115.0	377.2	11.530	52.74	38.0	2.1
120.0	393.6	11.730	53.11	30.0	1.6
125.0	410.0	11.830	53.29	20.0	1.1

TEMPERATURE, DEG C

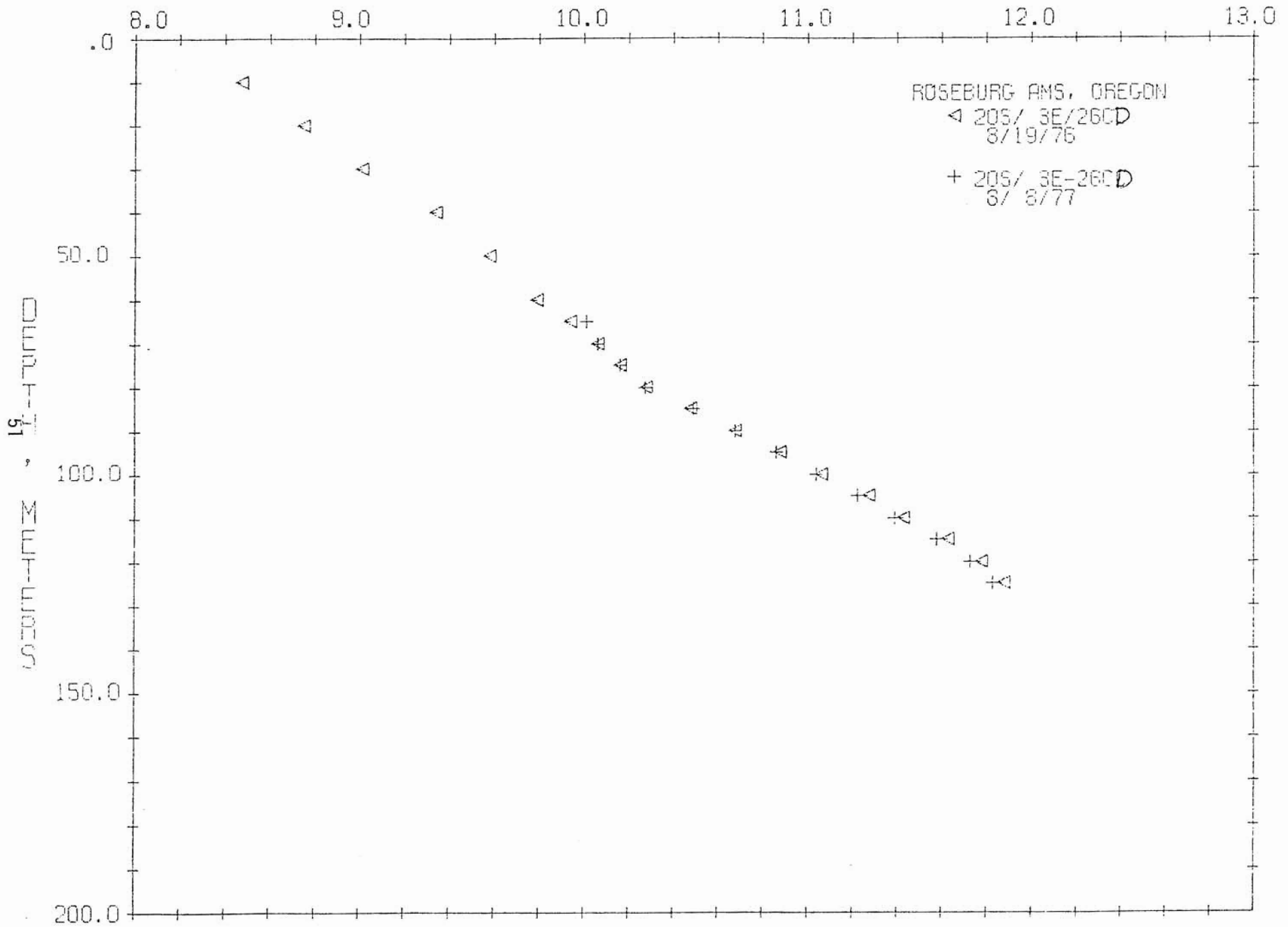

LOCATION: ROSEBURG AMS, OREGON
 205/ 3E-26CD
 HOLE NUMBER: AE-141
 DATE MEASURED: 8/19/76

DEPTH METERS	DEPTH FEET	TEMPERATURE		GEOTHERMAL GRADIENT	
		DEG C	DEG F	DEG C/KM	DEG F/100 FT
10.0	32.8	8.470	47.25	0.0	0.0
20.0	65.6	8.750	47.75	28.0	1.5
30.0	98.4	9.010	48.22	26.0	1.4
40.0	131.2	9.340	48.81	33.0	1.8
50.0	164.0	9.580	49.24	24.0	1.3
60.0	196.8	9.730	49.52	21.0	1.2
65.0	213.2	9.940	49.89	30.0	1.6
70.0	229.6	10.060	50.11	24.0	1.3
75.0	246.0	10.160	50.29	20.0	1.1
80.0	262.4	10.360	50.65	24.0	1.3
85.0	278.8	10.480	50.86	40.0	2.2
90.0	295.2	10.600	51.22	40.0	2.2
95.0	311.6	10.800	51.53	40.0	2.2
100.0	328.0	11.060	51.91	36.0	2.0
105.0	344.4	11.270	52.29	42.0	2.3
110.0	360.8	11.430	52.57	32.0	1.8
115.0	377.2	11.600	52.93	40.0	2.2
120.0	393.6	11.780	53.20	30.0	1.6
125.0	410.0	11.880	53.38	20.0	1.1

LOCATION: ROSEBURG AMS, OREGON

21S/ 5E-16CD

HOLE NAME: BLCK CRK

DATE MEASURED: 9/16/80

DEPTH METERS	DEPTH FEET	TEMPERATURE		GEOTHERMAL GRADIENT	
		DEG C	DEG F	DEG C/KM	DEG F/100 FT
42.0	137.9	7.890	46.20	0.0	0.0
44.0	144.3	7.490	45.48	-200.0	-11.0
46.0	150.9	7.510	45.52	10.0	0.5
48.0	157.4	7.530	45.55	10.0	0.5
50.0	164.0	7.560	45.61	15.0	0.8
52.0	170.6	7.580	45.64	10.0	0.5
54.0	177.1	7.600	45.68	10.0	0.5
56.0	183.7	7.630	45.73	15.0	0.8
58.0	190.2	7.650	45.77	10.0	0.5
60.0	196.8	7.650	45.77	0.0	0.0
62.0	203.4	7.660	45.79	5.0	0.3
64.0	209.9	7.660	45.79	0.0	0.0
66.0	216.5	7.670	45.81	5.0	0.3
68.0	223.0	7.680	45.82	5.0	0.3
70.0	229.6	7.690	45.84	5.0	0.3
72.0	236.2	7.700	45.86	5.0	0.3
74.0	242.7	7.710	45.88	5.0	0.3
76.0	249.3	7.710	45.88	0.0	0.0
78.0	255.8	7.720	45.90	5.0	0.3
80.0	262.4	7.750	45.95	15.0	0.8
82.0	269.0	7.780	46.00	15.0	0.8
84.0	275.5	7.810	46.06	15.0	0.8
86.0	282.1	7.830	46.09	10.0	0.5
88.0	288.6	7.830	46.09	0.0	0.0
90.0	295.2	7.840	46.11	5.0	0.3
92.0	301.8	7.890	46.20	25.0	1.4
94.0	308.3	7.900	46.22	5.0	0.3
96.0	314.9	7.880	46.18	-10.0	-0.5
98.0	321.4	7.930	46.27	25.0	1.4
100.0	328.0	7.940	46.29	5.0	0.3
102.0	334.6	7.900	46.22	-20.0	-1.1

TEMPERATURE, DEG C

54

DEPTH, METERS

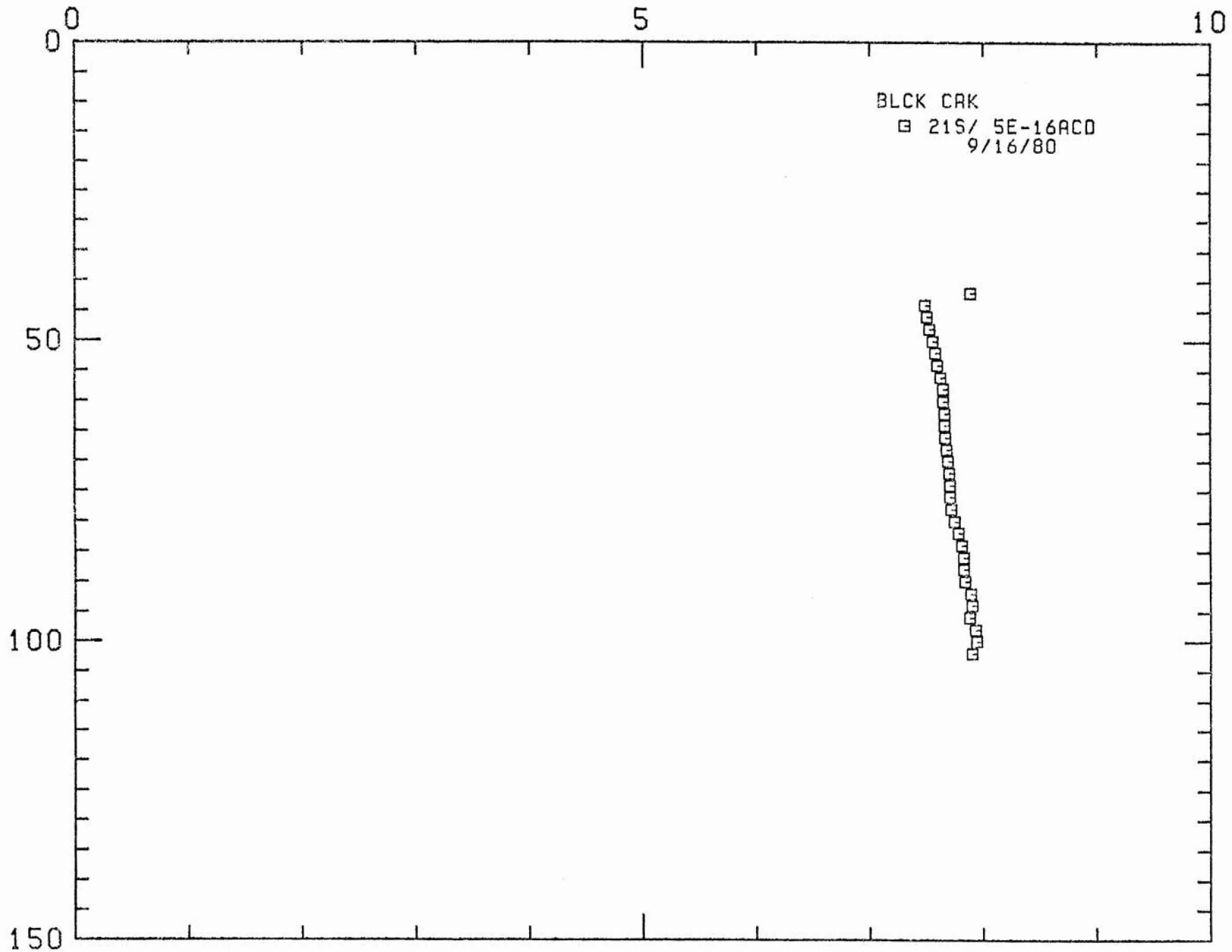

LOCATION: ROSEBURG AMS, OREGON

21S/ 3E-17DA

HOLE NAME: OAKR CW6

DATE MEASURED: 2/21/79

DEPTH METERS	DEPTH FEET	TEMPERATURE		GEOTHERMAL GRADIENT	
		DEG C	DEG F	DEG C/KM	DEG F/100 FT
5.0	16.4	12.250	54.05	0.0	0.0
10.0	32.8	12.280	54.10	6.0	0.3
15.0	49.2	12.860	55.15	116.0	6.4
20.0	65.6	13.010	55.42	30.0	1.6
25.0	82.0	13.110	55.60	20.0	1.1
30.0	98.4	13.380	56.08	54.0	3.0
35.0	114.8	13.550	56.39	34.0	1.9
40.0	131.2	13.730	56.71	36.0	2.0
45.0	147.6	13.900	57.02	34.0	1.9
50.0	164.0	14.160	57.49	52.0	2.9
55.0	180.4	14.440	57.99	56.0	3.1
60.0	196.8	14.760	58.57	64.0	3.5
65.0	213.2	14.920	58.86	32.0	1.8
70.0	229.6	15.160	59.29	48.0	2.6
75.0	246.0	15.500	59.90	68.0	3.7
80.0	262.4	15.780	60.40	56.0	3.1
85.0	278.8	15.870	60.57	18.0	1.0
90.0	295.2	15.990	60.78	24.0	1.3
95.0	311.6	16.100	60.98	22.0	1.2
100.0	328.0	16.210	61.18	22.0	1.2
105.0	344.4	16.930	62.47	144.0	7.9
105.0	344.4	16.930	62.47	0.0	0.0
110.0	360.8	17.120	62.82	38.0	2.1
115.0	377.2	17.380	63.28	52.0	2.9
120.0	393.6	17.620	63.72	48.0	2.6
125.0	410.0	17.710	63.88	18.0	1.0

TEMPERATURE, DEG C

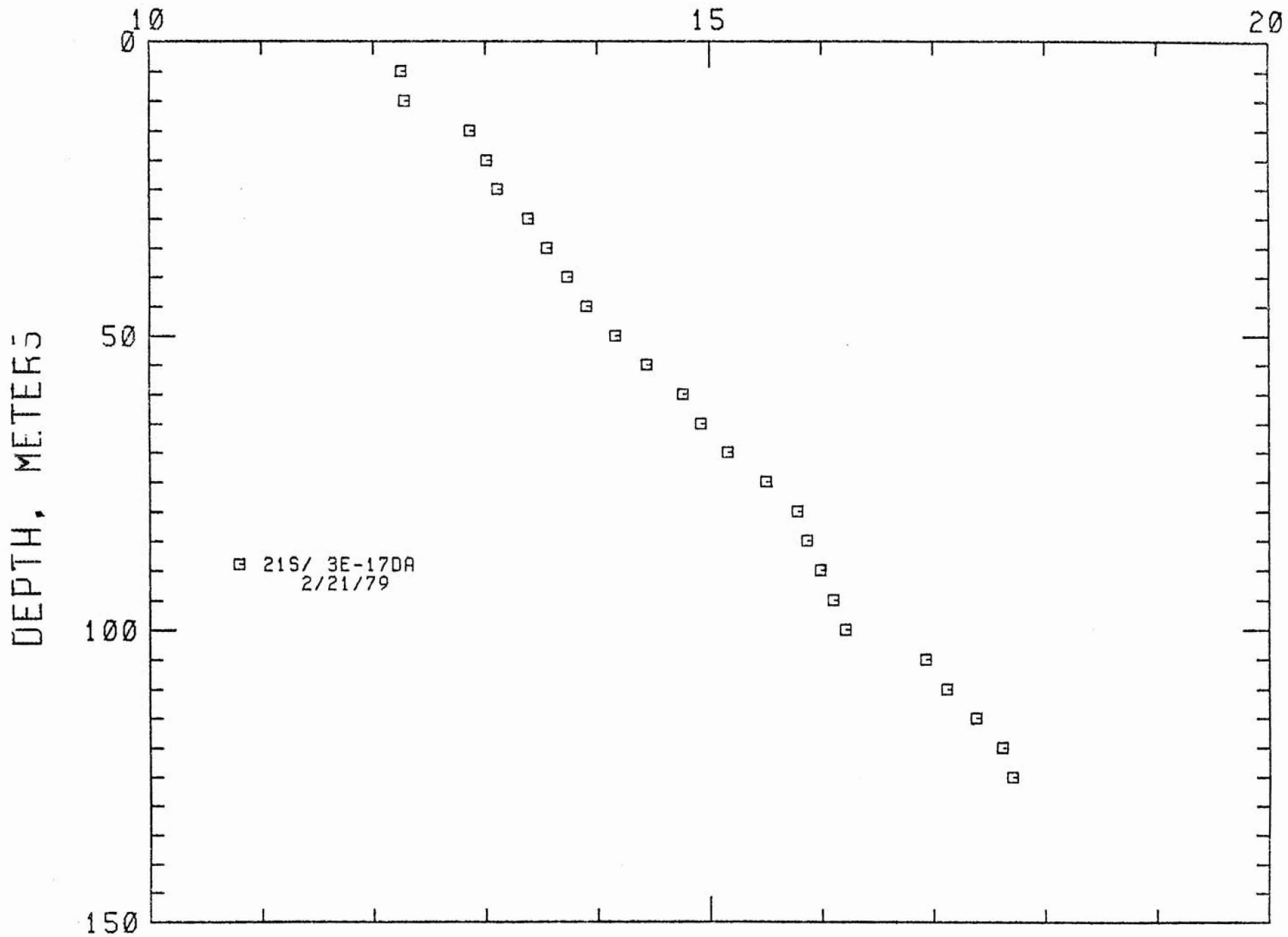

ROSEBURG AMS
 LOCATION: HILLS CREEK DAM, OREGON
 21S/ 3E-3533
 HOLE NUMBER: DH-2-5
 DATE MEASURED: 11/25/75

DEPTH METERS	DEPTH FEET	TEMPERATURE		GEO THERMAL GRADIENT	
		DEG C	DEG F	DEG C/KM	DEG F/100 FT
5.0	16.4	13.490	56.28	.0	.0
10.0	32.8	11.490	52.68	-400.0	-22.0
15.0	49.2	11.270	52.29	-44.0	-2.4
20.0	65.6	11.200	52.16	-14.0	-.8
25.0	82.0	11.050	51.89	-30.0	-1.6
30.0	98.4	10.890	51.60	-32.0	-1.8
35.0	114.8	10.740	51.33	-30.0	-1.6
40.0	131.2	10.610	51.10	-26.0	-1.4
45.0	147.6	10.480	50.86	-26.0	-1.4
50.0	164.0	10.420	50.76	-12.0	-.7
55.0	180.4	10.370	50.67	-10.0	-.5
60.0	196.8	10.340	50.61	-6.0	-.3
65.0	213.2	10.370	50.67	6.0	.3
70.0	229.6	10.390	50.70	4.0	.2
75.0	246.0	10.430	50.77	8.0	.4
79.0	259.1	10.450	50.81	5.0	.3

TEMPERATURE, DEG. C

8

9

10

11

12

13

14

D
E
P
T
H
,
M
E
T
E
R
S

25

50

75

100

125

CRESCENT & ROSEBURG AMS, OREGON

x 19S/11E/25BA

+ 21S/ 3E/35B3

58

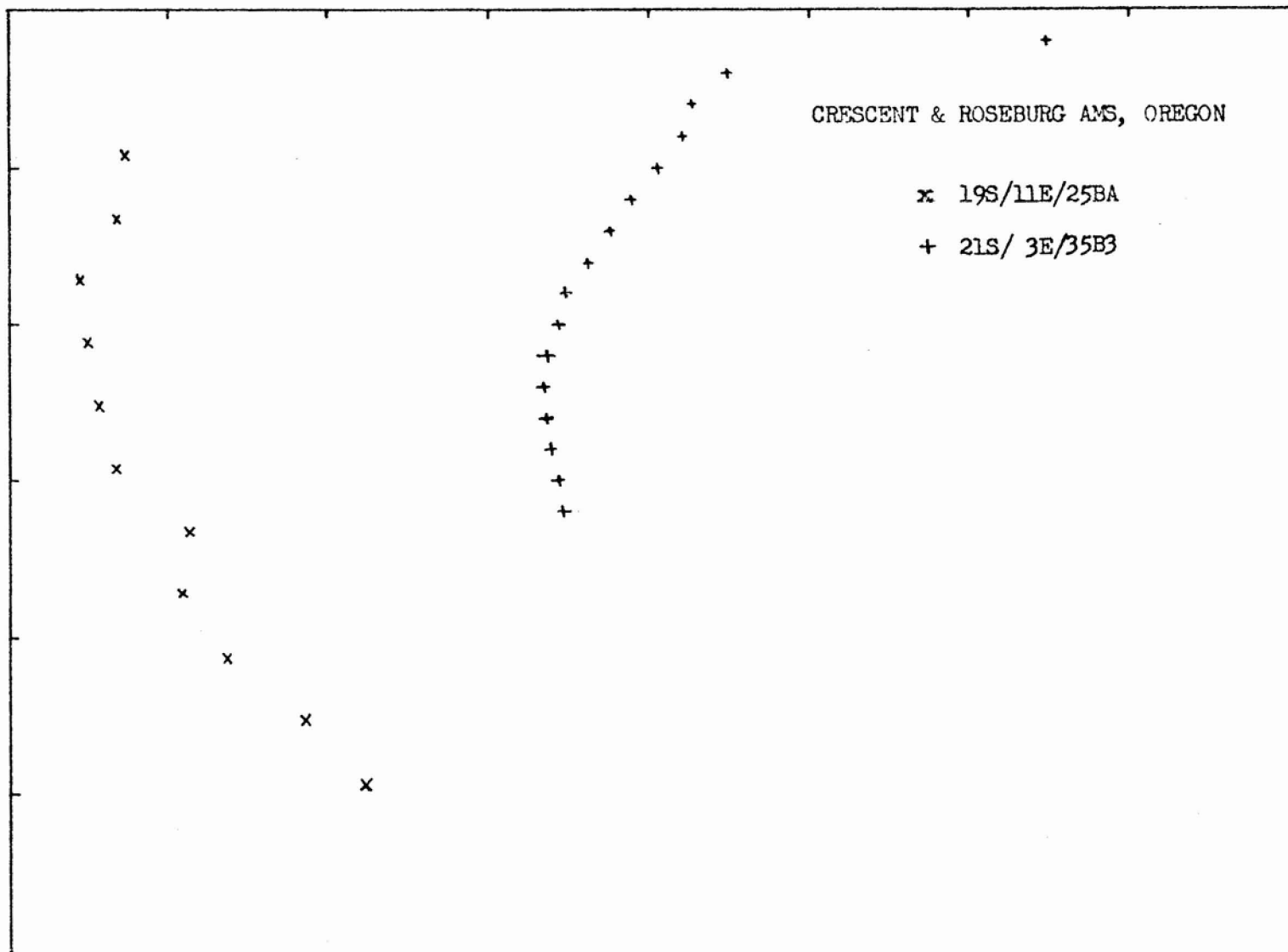

LOCATION: ROSEBURG AMS, OREGON

225/ 3E-10CD

HOLE NAME: PCCPG-WW

DATE MEASURED: 6/28/78

DEPTH METERS	DEPTH FEET	TEMPERATURE		GEOTHERMAL GRADIENT	
		DEG C	DEG F	DEG C/KM	DEG F/100 FT
20.0	65.6	11.140	52.05	0.0	0.0
25.0	82.0	11.410	52.54	54.0	3.0
30.0	98.4	11.540	52.77	26.0	1.4
35.0	114.8	11.710	53.08	34.0	1.9
40.0	131.2	11.890	53.40	36.0	2.0
45.0	147.6	12.040	53.67	30.0	1.6
50.0	164.0	12.190	53.94	30.0	1.6
55.0	180.4	12.520	54.54	66.0	3.6
60.0	196.8	12.670	54.81	30.0	1.6
65.0	213.2	12.870	55.17	40.0	2.2
70.0	229.6	13.060	55.51	38.0	2.1
75.0	246.0	13.280	55.90	44.0	2.4
80.0	262.4	13.490	56.28	42.0	2.3
85.0	278.8	13.690	56.64	40.0	2.2
90.0	295.2	13.890	57.00	40.0	2.2
92.0	301.8	13.980	57.16	45.0	2.5

TEMPERATURE, DEG C

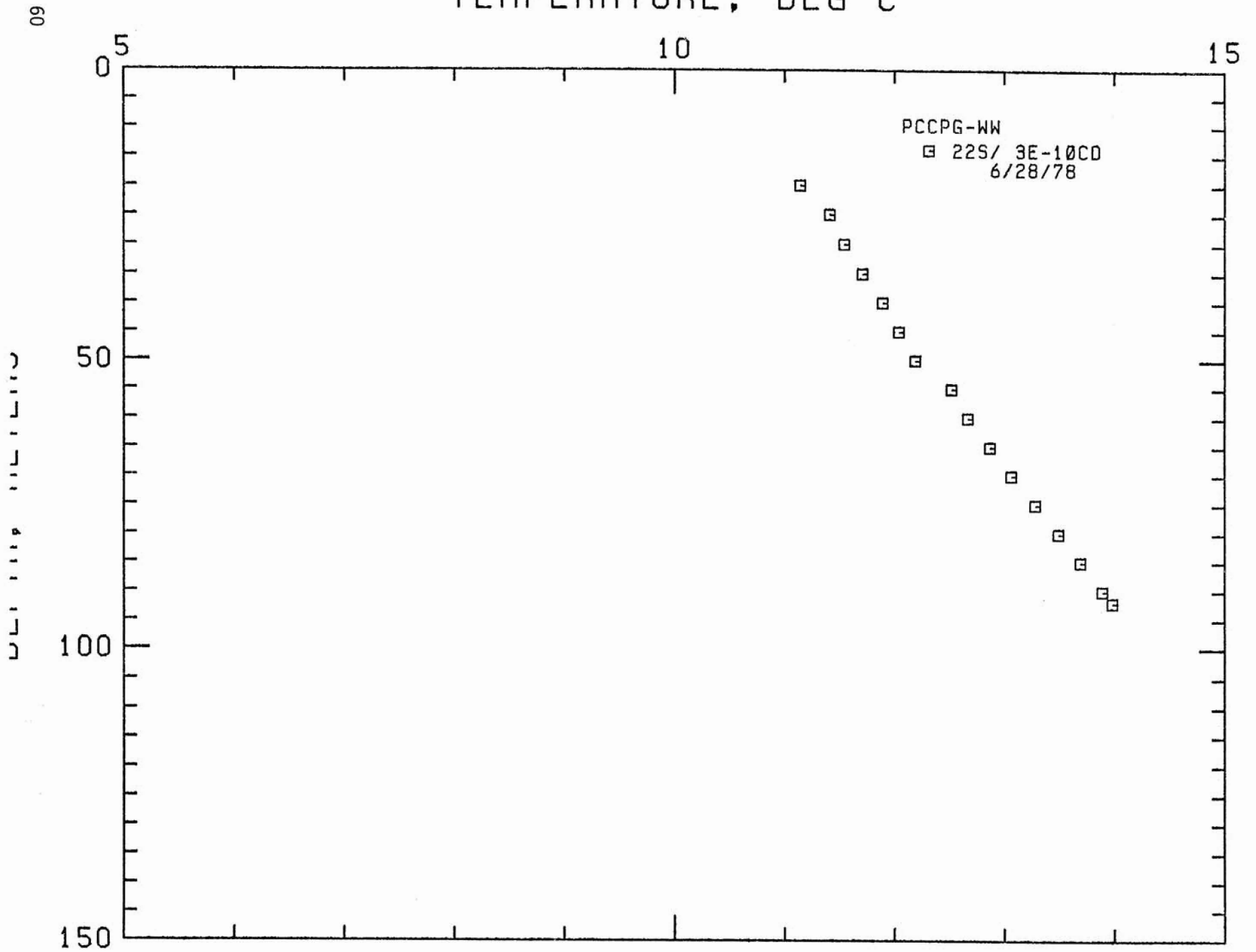

226/ 5E/263C
 HOLE NUMBER: CR-MCHSW
 DATE MEASURED: 9/29/76

DEPTH METERS	DEPTH FEET	TEMPERATURE		GEOHERMAL GRADIENT	
		DEG C	DEG F	DEG C/KM	DEG F/100 FT
10.0	32.8	8.340	47.01	.0	.0
15.0	49.2	8.560	47.41	44.0	2.4
20.0	65.6	8.630	47.53	14.0	.8
25.0	82.0	8.770	47.79	28.0	1.5
30.0	98.4	8.960	48.13	38.0	2.1
35.0	114.8	9.150	48.47	38.0	2.1
40.0	131.2	9.410	48.94	52.0	2.9
45.0	147.6	9.730	49.51	64.0	3.5
50.0	164.0	9.990	49.98	52.0	2.9
55.0	180.4	10.110	50.20	24.0	1.3
60.0	196.8	10.410	50.74	60.0	3.3
65.0	213.2	10.670	51.21	52.0	2.9
70.0	229.6	10.960	51.73	58.0	3.2
75.0	246.0	11.230	52.21	54.0	3.0
80.0	262.4	11.460	52.63	46.0	2.5
85.0	278.8	11.750	53.15	58.0	3.2
90.0	295.2	12.020	53.64	54.0	3.0
95.0	311.6	12.340	54.21	64.0	3.5
100.0	328.0	12.620	54.72	56.0	3.1
105.0	344.4	13.070	55.53	90.0	4.9
110.0	360.8	13.180	55.72	22.0	1.2
115.0	377.2	13.460	56.23	56.0	3.1
120.0	393.6	13.740	56.73	56.0	3.1
125.0	410.0	14.040	57.27	60.0	3.3
130.0	426.4	14.240	57.63	40.0	2.2
135.0	442.8	14.570	58.23	66.0	3.6
140.0	459.2	14.780	58.60	42.0	2.3
145.0	475.6	15.040	59.07	52.0	2.9
150.0	492.0	15.320	59.58	56.0	3.1

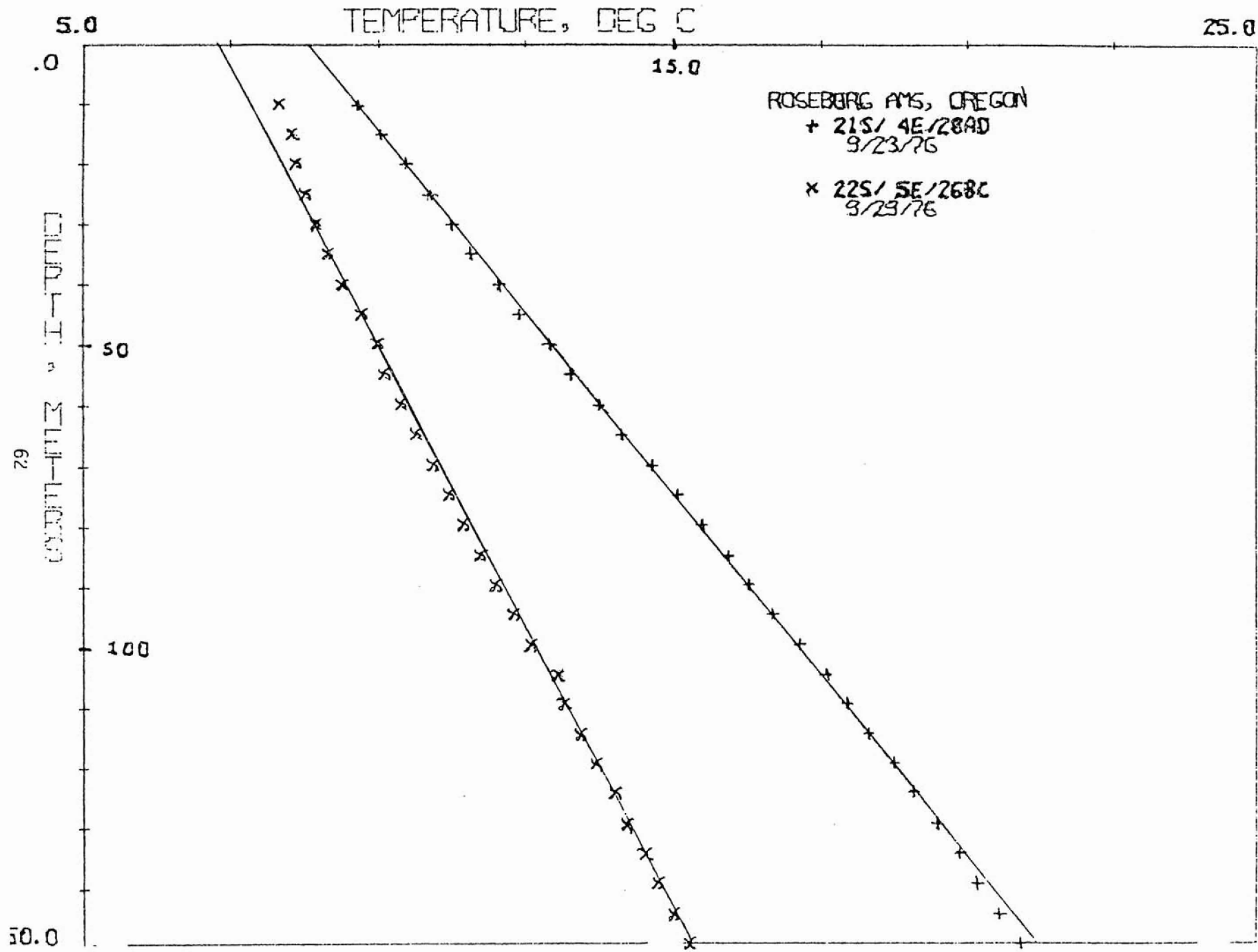

LOCATION: ROSEBURG AMS, OREGON

23S/ 5E- 8DAA

HOLE NAME: PNTD CRK

DATE MEASURED: 9/ 9/80

DEPTH METERS	DEPTH FEET	TEMPERATURE		GEOTHERMAL GRADIENT	
		DEG C	DEG F	DEG C/KM	DEG F/100 FT
34.0	111.5	6.710	44.08	0.0	0.0
36.0	118.1	6.670	44.01	-20.0	-1.1
38.0	124.6	6.680	44.02	5.0	0.3
40.0	131.2	6.720	44.10	20.0	1.1
42.0	137.8	6.770	44.19	25.0	1.4
44.0	144.3	6.850	44.33	40.0	2.2
46.0	150.9	6.960	44.53	55.0	3.0
48.0	157.4	7.060	44.71	50.0	2.7
50.0	164.0	7.270	45.09	105.0	5.8
52.0	170.6	7.490	45.48	110.0	6.0
54.0	177.1	7.730	45.91	120.0	6.6
56.0	183.7	7.980	46.36	125.0	6.9
58.0	190.2	8.220	46.80	120.0	6.6
60.0	196.8	8.380	47.08	80.0	4.4
62.0	203.4	8.570	47.43	95.0	5.2
64.0	209.9	8.770	47.79	100.0	5.5
66.0	216.5	8.970	48.15	100.0	5.5
68.0	223.0	9.180	48.52	105.0	5.8
70.0	229.6	9.320	48.78	70.0	3.8
72.0	236.2	9.450	49.01	65.0	3.6
74.0	242.7	9.610	49.30	80.0	4.4
76.0	249.3	9.790	49.62	90.0	4.9
78.0	255.8	9.970	49.95	90.0	4.9
80.0	262.4	10.120	50.22	75.0	4.1
82.0	269.0	10.320	50.58	100.0	5.5
84.0	275.5	10.510	50.92	95.0	5.2
86.0	282.1	10.730	51.31	110.0	6.0
88.0	288.6	10.940	51.69	105.0	5.8
90.0	295.2	11.320	52.38	190.0	10.4
92.0	301.8	11.430	52.57	55.0	3.0
94.0	308.3	11.510	52.72	40.0	2.2
96.0	314.9	11.680	53.02	85.0	4.7
98.0	321.4	11.820	53.28	70.0	3.8
100.0	328.0	11.980	53.56	80.0	4.4
102.0	334.6	12.140	53.85	80.0	4.4
104.0	341.1	12.310	54.16	85.0	4.7
106.0	347.7	12.470	54.45	80.0	4.4
108.0	354.2	12.620	54.72	75.0	4.1
110.0	360.8	12.810	55.06	95.0	5.2
112.0	367.4	12.950	55.31	70.0	3.8
114.0	373.9	13.080	55.54	65.0	3.6

LOCATION: ROSEBURG AMS, OREGON

PAGE 2

235/ SE- 8DAA

HOLE NAME: PNTD CRK

DATE MEASURED: 9/ 9/80

DEPTH METERS	DEPTH FEET	TEMPERATURE		GEOHERMAL GRADIENT	
		DEG C	DEG F	DEG C/KM	DEG F/100 FT
116.0	380.5	13.390	56.10	155.0	8.5
118.0	387.0	13.520	56.34	65.0	3.6
120.0	393.6	13.610	56.50	45.0	2.5
122.0	400.2	13.770	56.79	80.0	4.4
124.0	406.7	13.890	57.00	60.0	3.3
126.0	413.3	14.000	57.20	55.0	3.0
128.0	419.8	14.110	57.40	55.0	3.0
130.0	426.4	14.200	57.56	45.0	2.5
132.0	433.0	14.350	57.83	75.0	4.1
134.0	439.5	14.450	58.01	50.0	2.7
136.0	446.1	14.640	58.35	95.0	5.2
138.0	452.6	14.790	58.62	75.0	4.1
140.0	459.2	14.910	58.84	60.0	3.3
142.0	465.8	15.150	59.27	120.0	6.6
144.0	472.3	15.310	59.56	80.0	4.4
146.0	478.9	15.490	59.88	90.0	4.9
148.0	485.4	15.650	60.17	80.0	4.4
150.0	492.0	15.790	60.42	70.0	3.8
152.0	498.6	15.900	60.62	55.0	3.0

TEMPERATURE, DEG C

